

APPROVAL SHEET

AOT MODEL NAME	7020
AOT PART NUMBER	7020C-W317
CUSTOMER NAME	General Customer
DATE	2021/ Oct.
Version	01

MAKER			CUSTOMER			
Prepared	Checked	Approved				

Revision Note

Date	Revision	Page	Version
2021-10-15	Initiate Document	18	01

Package Outline

Model name: 7020C-W317

Unit: mm, Tolerance: ± 0.2 mm

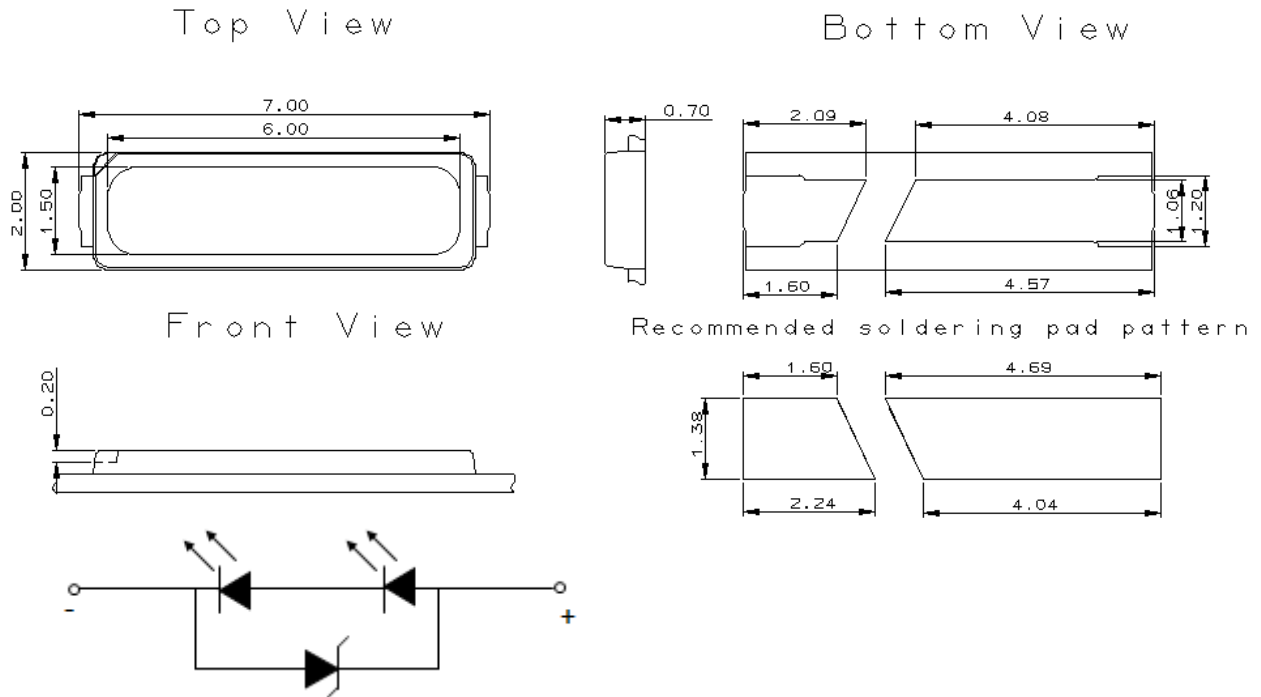

Item	Materials
Package	Heat-Resistant Polymer
Encapsulating Material	Silicone(with phosphor)
Electrode	Ag Plating Copper Alloy

- Single blue chip.
- High brightness SMD.
- Compact package outline (LxWxH) of 7.0 mm x 2.0 mm x 0.7 mm.
- Compatible with reflow soldering.
- Complies with RoHS Directive.

Optical/Electronic Characteristics (TA=25°C)

Item	Symbol	Condition	Min	Typ.	Max	Unit
Forward Voltage	V _F	I _F = 150mA	5.7	-	6.6	V
Luminous Flux	Φ _V	I _F = 150mA	102	-	120	lm

* Tolerance of measurements of the Forward Voltage is ± 0.05 V.

* Tolerance of measurements of the Luminous Flux is ± 5%.

Absolute Maximum Ratings (TA=25°C)

Item	Symbol	Absolute Maximum Rating	Unit
Forward Current	I _F	240	mA
*Pulse Forward Current	I _{FP}	360	mA
Power Dissipation	P _D	1584	mW
Reverse Voltage	V _R	5	V
Operating Temperature	T _{opr}	-40~+85	°C
Storage Temperature	T _{stg}	-40~+100	°C
Soldering Temperature	T _{slid}	Reflow Soldering : 260°C for 10sec	
Junction Temperature	T _j	125	°C
Forward Voltage at Low Current	V _{F2}	>3.8 (@1 μ A)	V

* I_{FP} Conditions: Pulse Width ≤ 10msec, and duty ≤ 1/10

* Max condition is not guarantee for life time

Group Definition of Forward Voltage

Rank	Condition	V_F(V)
X11	T _A =25°C I _F =150mA	5.7 ~ 6.0
X12		6.0 ~ 6.3
X13		6.3 ~ 6.6

Group Definition of Brightness

Rank	Condition	Luminous Flux(lm)
A102	T _A =25°C I _F =150mA	102 ~ 105
A105		105 ~ 108
A108		108 ~ 111
A111		111 ~ 114
A114		114 ~ 117
A117		117 ~ 120

* A shipment shall consist of LEDs in a combination of above ranks.

* The percentage of each rank in the shipment shall be determined by AOT.

* The ranking information of LEDs can be found on the reel label.

Group Definition of Chromaticity Coordinate(25°C)

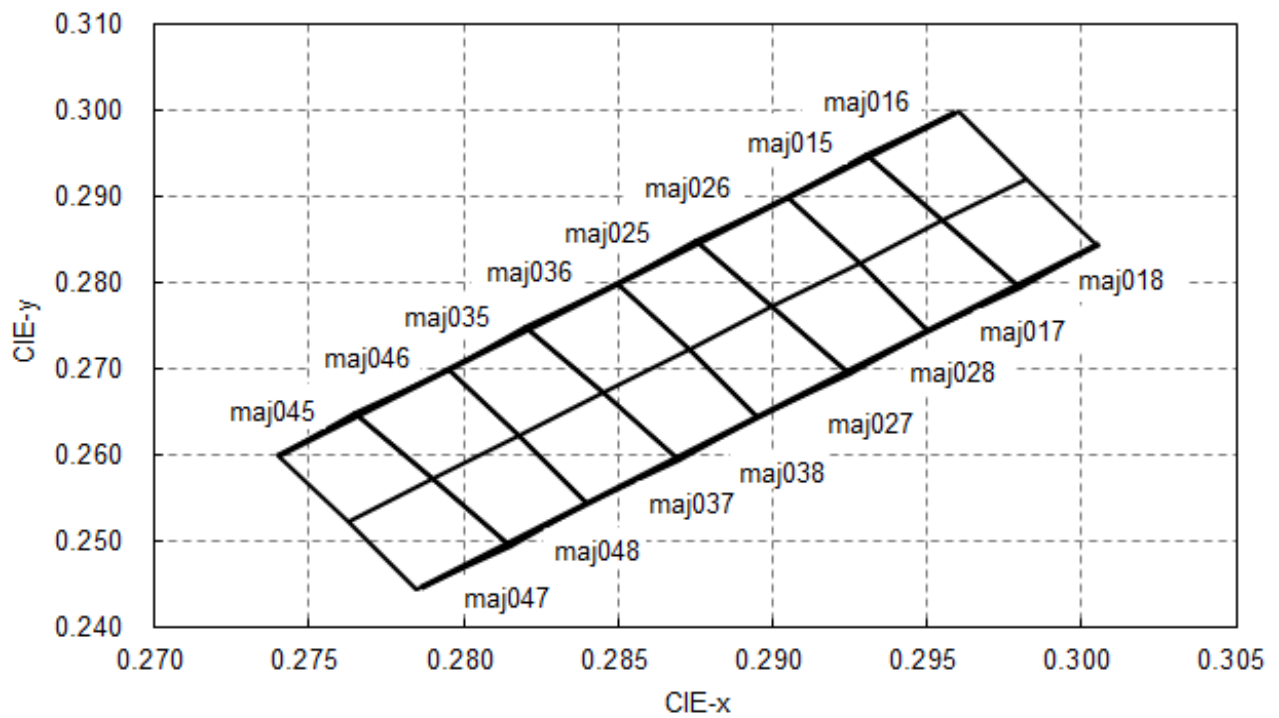

Color Rank

Rank	x	y	Rank	x	y	Rank	x	y
maj015	0.2905	0.2900	maj025	0.2850	0.2800	maj035	0.2795	0.2700
	0.2930	0.2950		0.2875	0.2850		0.2820	0.2750
	0.2955	0.2873		0.2900	0.2773		0.2845	0.2673
	0.2928	0.2823		0.2873	0.2723		0.2818	0.2623
maj016	0.2930	0.2950	maj026	0.2875	0.2850	maj036	0.2820	0.2750
	0.2960	0.3000		0.2905	0.2900		0.2850	0.2800
	0.2982	0.2922		0.2928	0.2823		0.2873	0.2723
	0.2955	0.2873		0.2900	0.2773		0.2845	0.2673
maj017	0.2928	0.2823	maj027	0.2873	0.2723	maj037	0.2818	0.2623
	0.2955	0.2873		0.2900	0.2773		0.2845	0.2673
	0.2980	0.2795		0.2925	0.2695		0.2870	0.2595
	0.2950	0.2745		0.2895	0.2645		0.2840	0.2545
maj018	0.2955	0.2873	maj028	0.2900	0.2773	maj038	0.2845	0.2673
	0.2982	0.2922		0.2928	0.2823		0.2873	0.2723
	0.3005	0.2845		0.2950	0.2745		0.2895	0.2645
	0.2980	0.2795		0.2925	0.2695		0.2870	0.2595

Rank	x	y	Rank	x	y	Rank	x	y
maj045	0.2740	0.2600	maj046	0.2765	0.2650	maj047	0.2763	0.2523
	0.2765	0.2650		0.2795	0.2700		0.2790	0.2573
	0.2790	0.2573		0.2818	0.2623		0.2815	0.2495
	0.2763	0.2523		0.2790	0.2573		0.2785	0.2445
maj048	0.2790	0.2573						
	0.2818	0.2623						
	0.2840	0.2545						
	0.2815	0.2495						

Note: Chromaticity coordinate groups are measured with an accuracy of ± 0.005 .

Optical and electrical characteristics

Forward Voltage vs. Forward Current

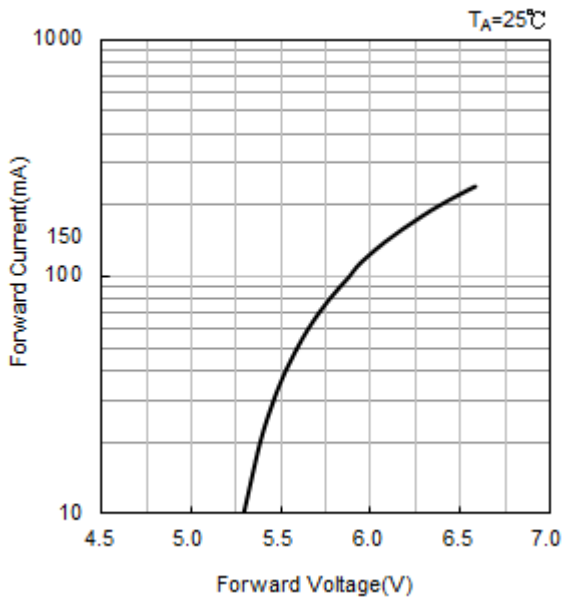

Forward Current vs. Relative Luminous Flux

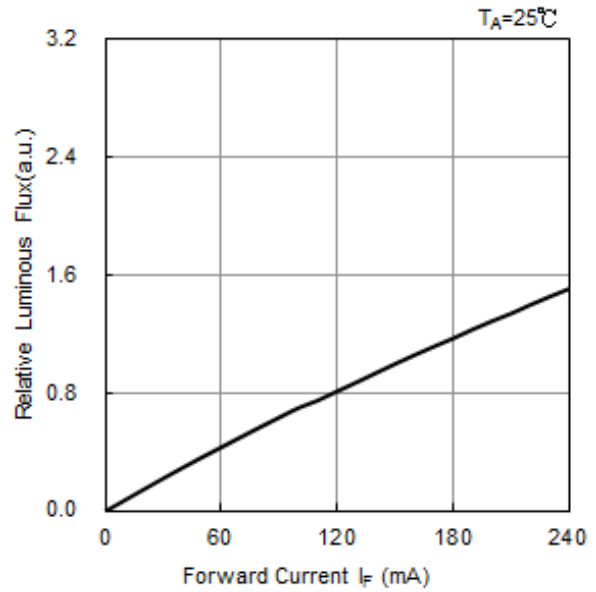

Ambient Temperature vs. Forward Voltage

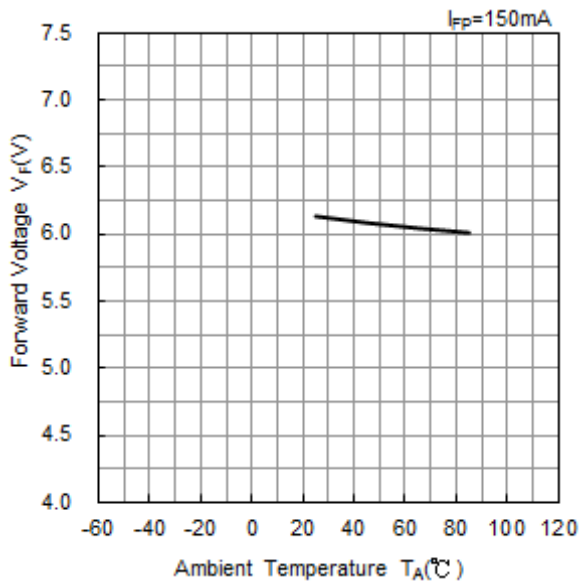

Ambient Temperature vs. Relative Luminous

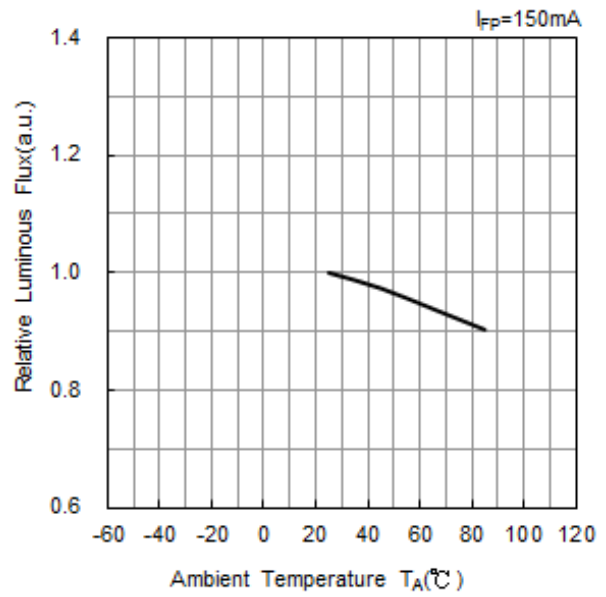

Forward Current vs. Chromaticity Coordinate

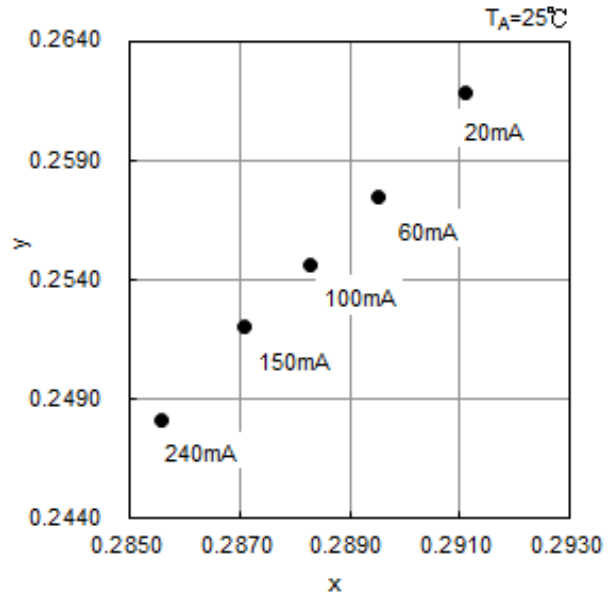

Ambient Temperature vs. Chromaticity Coordinate

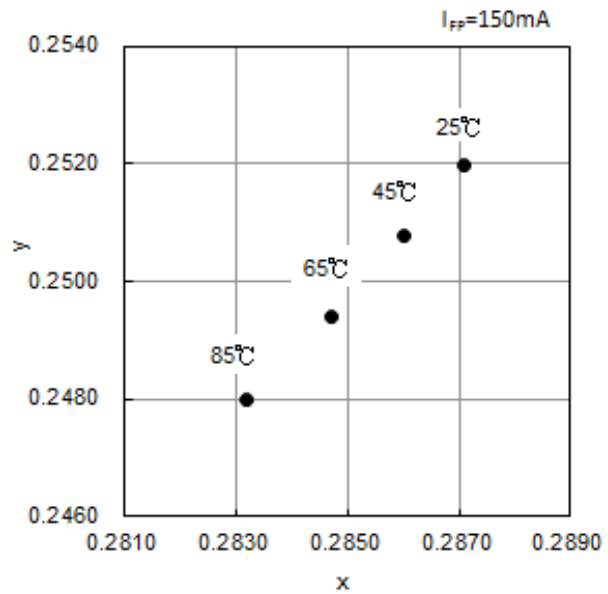

■ Spectrum($T_A=25^\circ\text{C}, I_{FP}=150\text{mA}$)

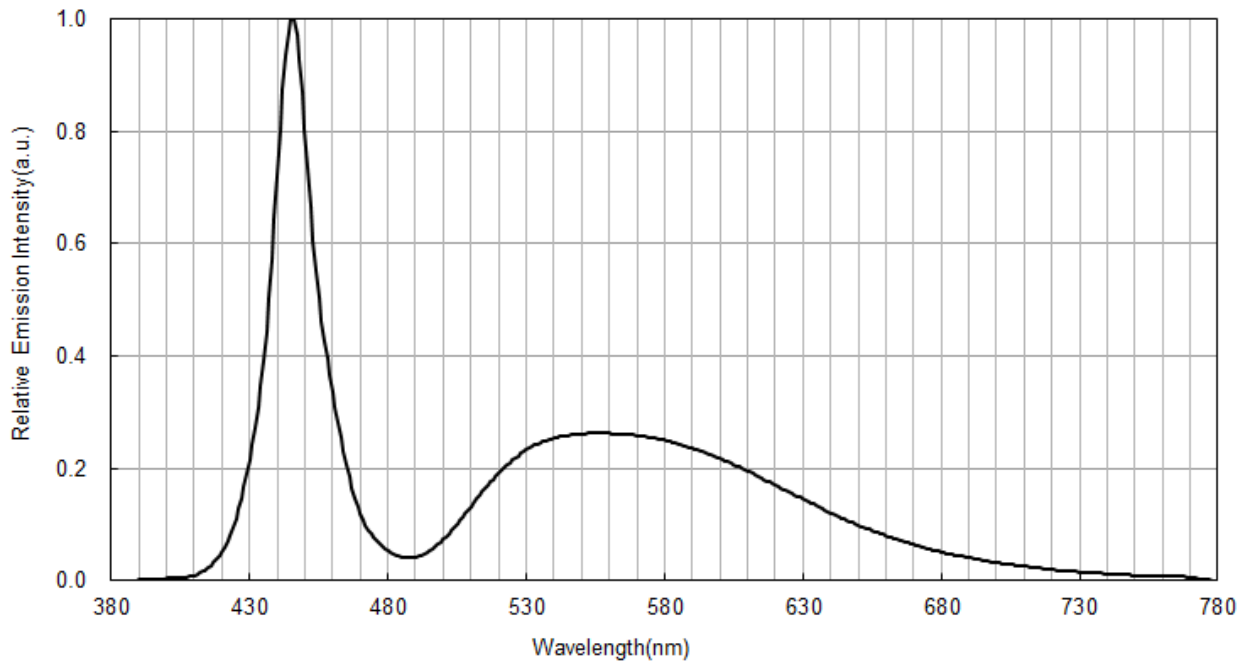

■ Radiation Pattern($T_A=25^\circ\text{C}, I_{FP}=150\text{mA}$)

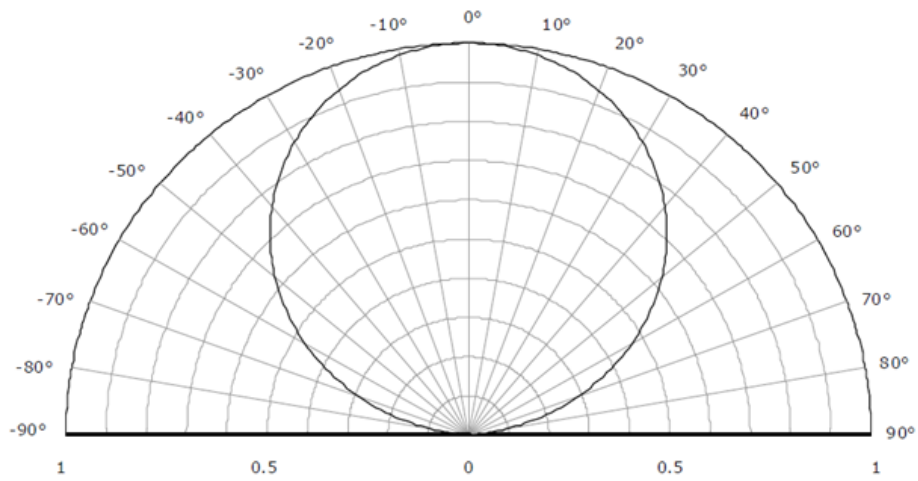

Recommended Reflow Soldering Conditions

Surface Mounting Condition

In automatic mounting of the SMD LEDs on printed circuit boards, any bending, expanding and pulling forces or shock against the SMD LEDs should be kept min. to prevent them from electrical failures and mechanical damages of the devices.

Soldering Reflow

-Soldering of the SMD LEDs should conform to the soldering condition in the individual specifications.

-SMD LEDs are designed for Reflow Soldering.

-In the reflow soldering, too high temperature and too large temperature gradient such as rapid heating/cooling may cause electrical & optical failures and damages of the devices.

-AOT cannot guarantee the LEDs after they have been assembled using the solder dipping method.

1) Lead Solder

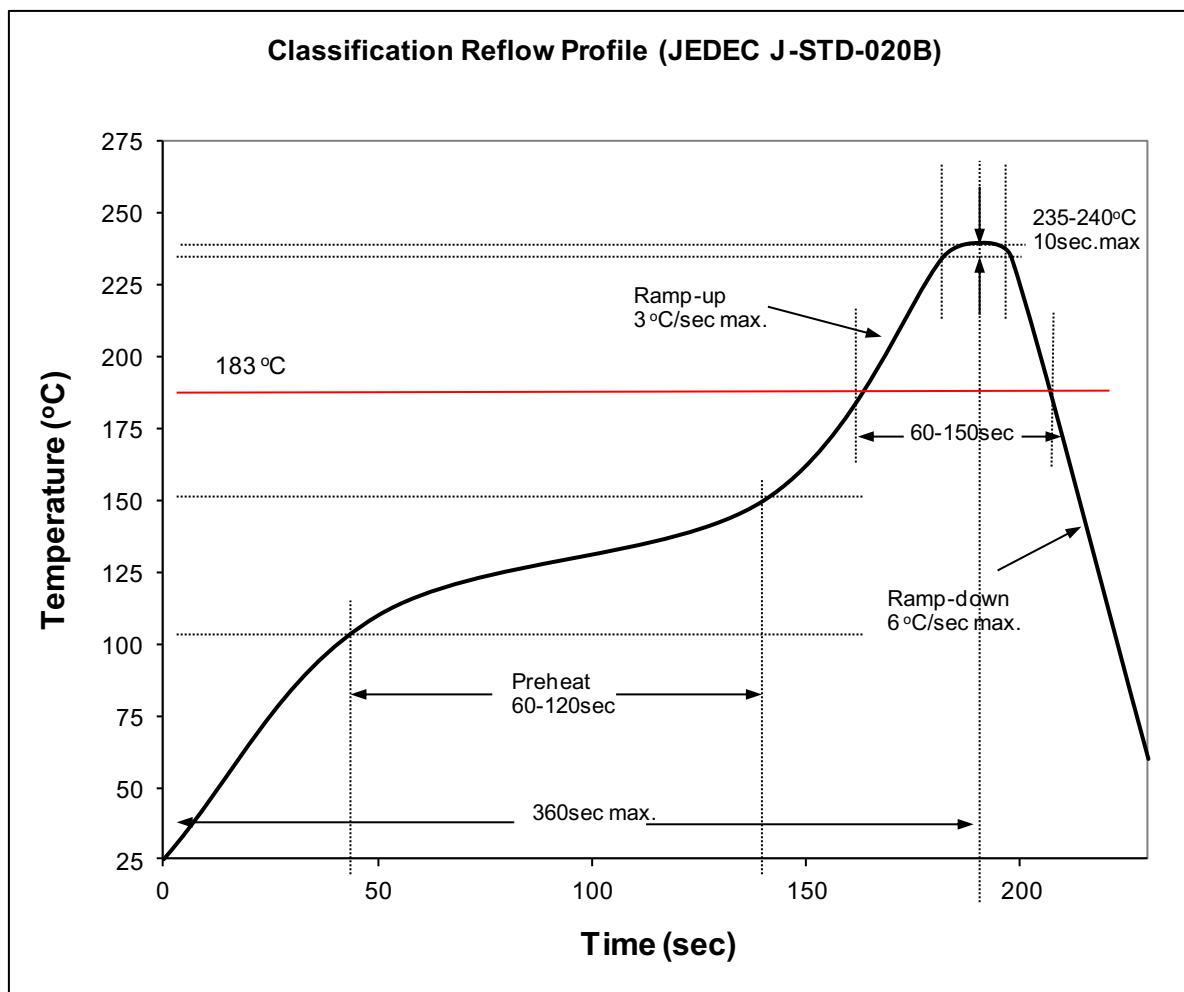

2) Lead-Free Solder

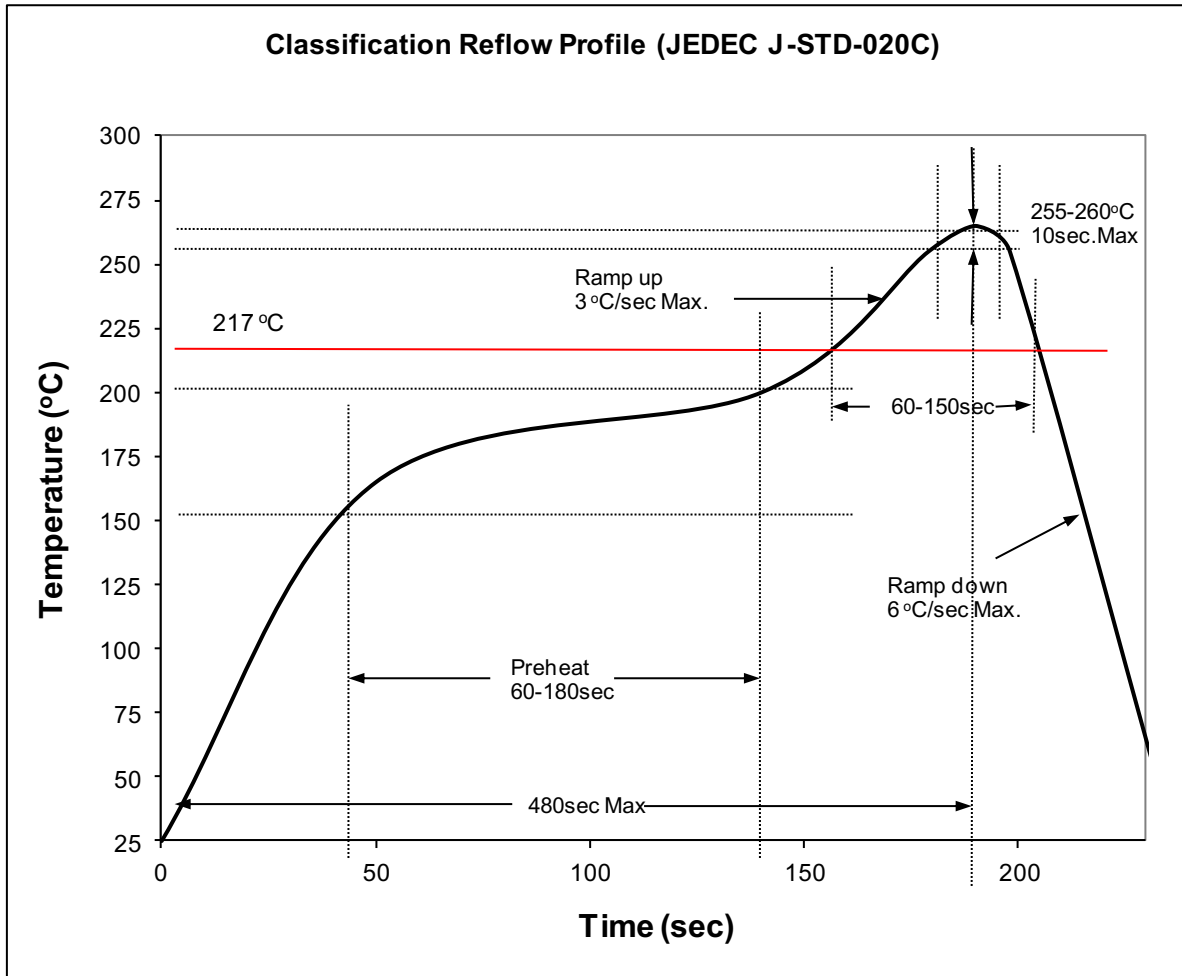

3) Manual Soldering Conditions

- Lead Solder

Max. 300 °C for Max. 3sec, and only one time.

- Lead-free Solder

Max. 350 °C for Max. 3sec, and only one time.

- There is possibility that the brightness of LEDs is decreased, which is influenced by heat or ambient atmosphere during reflow. It is recommended to use the nitrogen reflow method.

- After LEDs have been soldered, repair should not be done. As repair is unavoidable, a double-head soldering iron should be used. It should be confirmed beforehand whether the characteristics of the LEDs will be damaged by repairing or not.

- Reflow soldering should not be done more than two times.

Dimensions (Unit :mm)

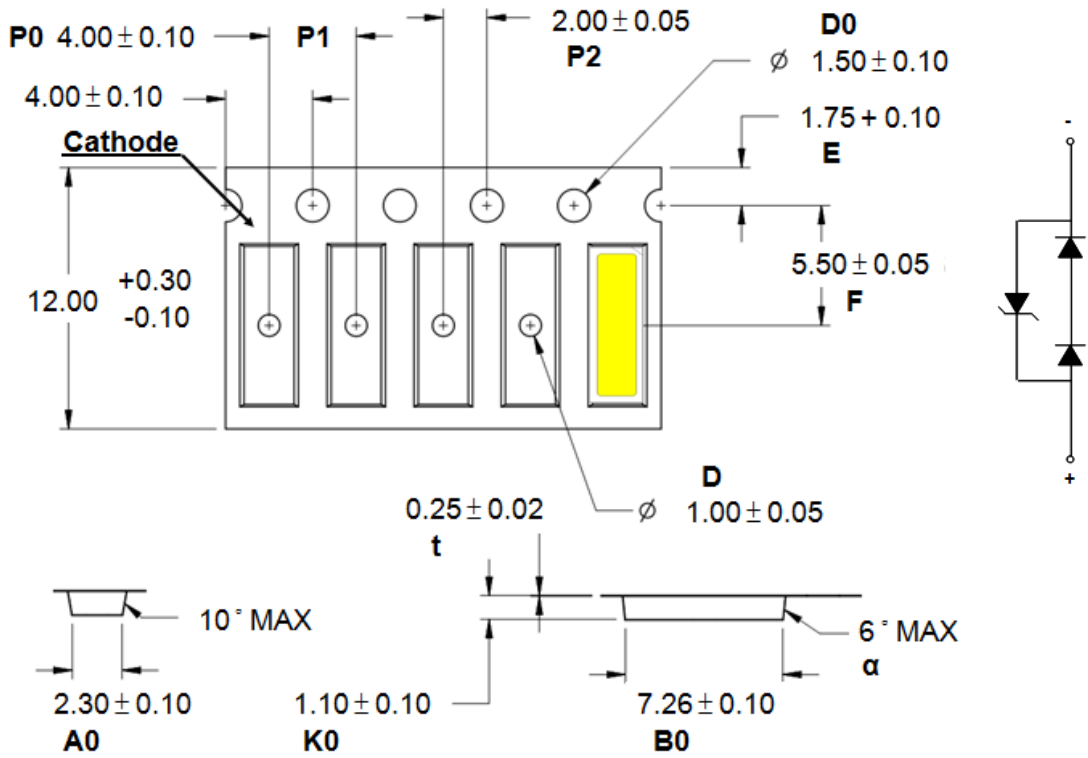

Item	Spec.	Tolerance(mm)	Item	Spec.	Tolerance(mm)
W	12.00	+0.30, -0.10	P2	2.00	±0.05
E	1.75	±0.10	t	0.25	±0.02
F	5.50	±0.05	A0	2.30	±0.10
D	1.00	±0.05	B0	7.26	±0.10
D0	1.50	±0.10	K0	1.10	±0.10
P0	4.00	±0.10	α	Max 6°	

Packing Formation

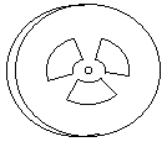

Diameter : 178 mm
 Width : 8 mm
 3,500 pcs/Reel
 Antistatic Reel

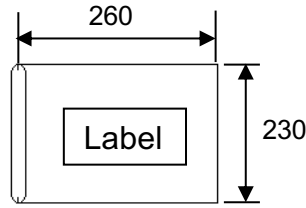
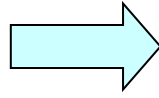

MBB Bag
 +5g drying agent
 +Humidity card
 1 Reel / Bag

50 Bags /1 Carton
 ⇒ 175,000 pcs/ 1Carton

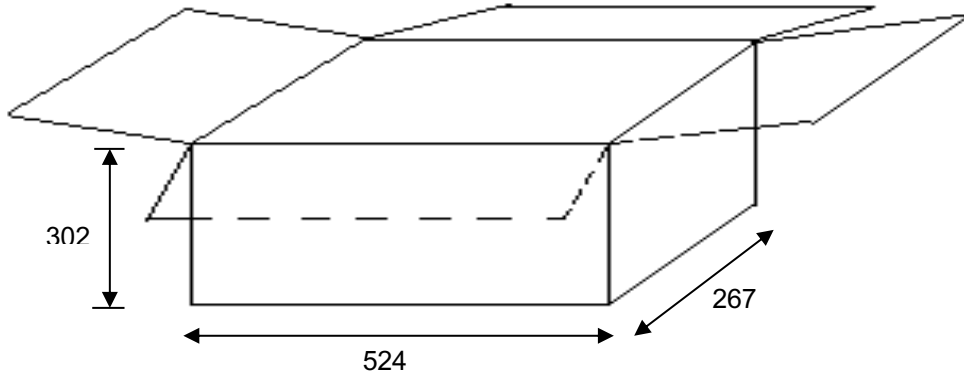
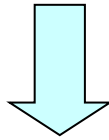

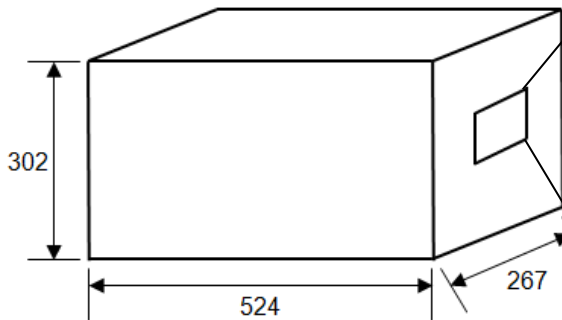

Package Outlook



 Solid-State Light. Done Right. Advanced Optoelectronic Technology Inc.	
Customer	
PO No.	
Part No.	
Quantity	
Packing Date	
Carton No.	
Ship No.	
QC Check	 
備註	

Reel Label Definition

SMD LED	SAP. No.
Part Number : XXXXX-XXXX	
Brightness : A	
CIE : B	
VF : C	
Quantity : nn ea	
Serial No : SM0yymmddxxxx	
	
Cust. PN. : XXXXX-XXXX	

A : Iv value.
B : CIE value noted
C : Vf value.
nn : Quantity of LED

SM0yymmddxxx : yy : year, mm : month, dd : day, xxxx : reel no.

*Reel Label to fill in practice data of all LED characteristic

Reliability Test

No.	Test Item	Standard Test Method	Test Conditions	Note	Number of Damaged
1	Room Temp. Life Test	Internal Ref.	$T_A=25^{\circ}\text{C}, I_F=150\text{mA}$	1000 hr	0/20
2	High Temp. Operation	JESD22-A108	$T_A=65^{\circ}\text{C}, I_F=150\text{mA}$	1000 hr	0/20
3	High Temp. Operation	JESD22-A108	$T_A=85^{\circ}\text{C}, I_F=150\text{mA}$	1000 hr	0/20
4	High Temp. Storage	JESD22-A103	$T_A=100^{\circ}\text{C}$	1000 hr	0/20
5	Low Temp. Operation	JESD22-A108	$T_A=-40^{\circ}\text{C}, I_F=150\text{mA}$	1000 hr	0/20
6	High Temp. and High Humidity Operation	JESD22-A119	$60^{\circ}\text{C } 90\% \text{RH}, I_F=150\text{mA}$	1000 hr	0/20
7	Temperature and humidity cycle test	IEC68-2-38	$25^{\circ}\text{C} \sim 65^{\circ}\text{C} \sim -10^{\circ}\text{C}, 90\% \text{RH}$ 24hr per cycle	10 cycle	0/20
8	Thermal Cycling Test	JESD22-A106	$-40^{\circ}\text{C} \sim 100^{\circ}\text{C}$, 30min Transform time 5min	300 cycles	0/50

Criteria for Judging Damage

Item	Symbol	Test Conditions	Criteria for Judgement	
			Min.	Max.
Forward Voltage	V_F	$I_F=150\text{mA}$	-	*U.S.L \times 1.1
Luminous Flux	ϕ_v	$I_F=150\text{mA}$	*L.S.L \times 0.7	-

* U.S.L: Upper Standard Level

* L.S.L: Lower Standard Level

Thermal Test Condition

Light Bar Thermal Test Condition				
PKG Model	PCB Temperature($^{\circ}\text{C}$)	Test Current(mA)	Test Time(s)	Judgment
7020C-W317	120 ± 10	150 ± 1	10	No LED OFF

※ SMT must be done Thermal Test Condition

※ PCB Temperature must reach 110°C for 5 seconds

Cautions

(1) Moisture Proof Package

The moisture proof package should be used to prevent moisture in the package as the moisture may Cause damage to optical characteristics of the LEDs.

The aluminum bag with zipper is used for moisture proof package. And, the moisture absorbent Material, Silica gel, is inserted into aluminum bag.

(2) Storage:

Storage Conditions

Before opening the package:

The LEDs should be kept at 30°C or less than 90%RH or less. The LEDs should be used within a year. When storing the LEDs, moisture proof packaging with absorbent material is recommended.

After opening the package:

After open the package, the LED should be kept at 30°C, 60%RH or less. The LED should be soldered within 168 hours (7 days) after opening the package. If unused LEDs remain, it should be stored in moisture proof condition.

(3) Heat Generation

Thermal design of the end products is of paramount importance. The heat generation must be taken into design consideration when using the LED. The coefficient of the temperature increase per input electric power is affected by the thermal resistance of the circuit board and density of LED placement on the board, as well as other components.

(4) Static Electricity

Static electricity or surge voltage damages the LEDs. All equipment and machinery must be properly grounded. It is recommended to use a wristband or anti-electrostatic glove when handling the LEDs. When inspecting the final products in which LEDs were assembled, it is recommended to check whether the assembled LEDs are damaged by static electricity or not. It is easy to find static-damaged LEDs by a light-on test or a Vf test at a lower current. (Below 1mA is recommended).

Criteria: $V_F > 3.8V$ at $I_F = 1 \mu A$

(5) Cleaning

Use isopropyl alcohol as a solvent for cleaning the LEDs. The other solvent may dissolve the LEDs package and the epoxy.

Ultrasonic cleaning should not be done.

(6) Electrostatic Discharge (ESD)

The products are sensitive to static electricity or surge voltage, An ESD event may damage its die or reduce its reliability performance. When handling the products, measures against electro static discharge, including the followings, are strongly recommended.

Eliminating the charge;

Wrist strap, ESD footwear and garments, ESD floors

Grounding the equipment and tools at workstation

ESD table / shelf mat (conductive materials)

Proper grounding techniques are required for all devices, equipment and machinery used in the assembly of the products, Also note that surge protection should be considered in the design of customer products.

If tools or equipment contain insulating materials, such as glass or plastic, proper measures against electro static discharge, including the followings are strongly recommended.

Dissipating the charge with conductive materials

Preventing the charge generation with moisture

Neutralizing the charge with ionizer

(7) Others

When using the LEDs, it must care that the reverse voltage will not exceed the absolute maximum rating.

The LED light is enough to injure human eyes, so it should avoid looking at LED light directly.

NOTE.

All the information published is considered to be reliable. However, AOT does not assume any liability arising out of the application or use of any product described herein.

AOT reserves the right to make changes at any time without notice to any products in order to improve reliability, function or design.

AOT products are not authorized for use as critical components in life support devices or systems without the express written approval from the managing director of AOT.