



Solid-State Light. Done Right.

APPROVAL SHEET

AOT MODEL NAME	3806
AOT PART NUMBER	3806C-W3CV
CUSTOMER NAME	General
DATE	2021 / Oct
VERSION	01

MAKER			CUSTOMER			
Prepared	Checked	Approved				
<i>M.chen</i>	<i>Sam</i>	<i>Sinfan</i>				

AOT Headquarters
No. 13, Gongye 5th. Road, Hsinchu Industrial Park, Hukou Shiang,
Hsinchu Hsien 303, Taiwan, R.O.C.
TEL: +886-3-597-6988 / FAX: +886-3-598-7392



Solid-State Light. Done Right.

Revision Note

Date	Revision	Page	Version
2021-10-15	Initiate Document	--	01

Package Outline

Model name: **3806C-W3CV**

Unit: mm, Tolerance: ± 0.1 mm

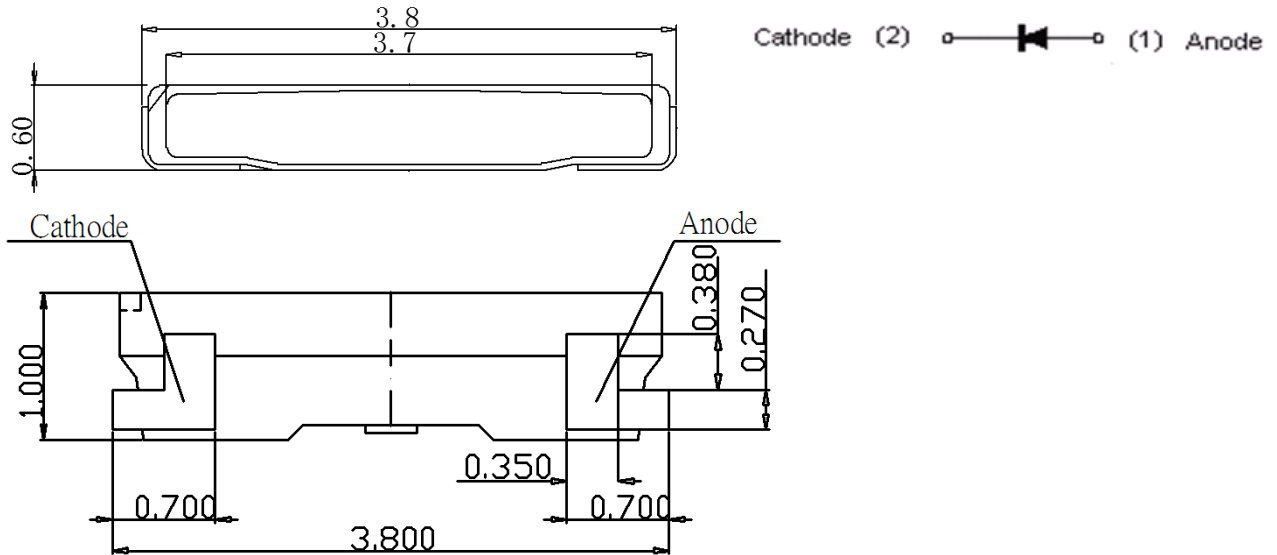

Recommended Soldering Pad design (Unit :mm)

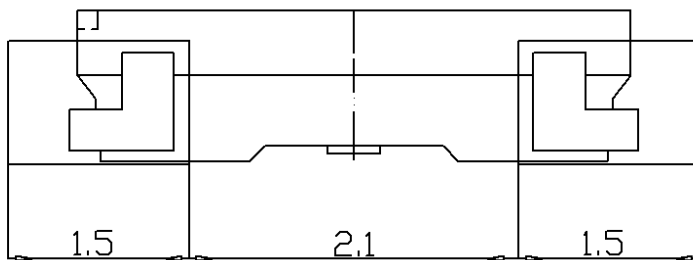

Item	Materials
Package	High Temperature Resistant Plastic, PPA.
Encapsulating	Silicone Resin(with phosphor)
Electrode	Cu Alloy With Ni, Ag Plating.

- SMD type Side-View white LED.
- Lead frame package with individual 2 pins.
- Wide viewing angle(120°)
- Compatible with reflow soldering.
- Complies with RoHS Directive.
- The Encapsult surface should be under the package surface, and should not expose the wire.
- Compact package outline (L x W x H) of 3.8 mm x 1.0 mm x 0.6mm.

Optical/Electronic Characteristics (T_A=25°C)

Item	Symbol	Condition	Value	Unit
Forward Voltage	V _F	I _F = 20mA	2.7 ~ 3.0	V
Luminous Flux	Φ _v	I _F = 20mA	2700 ~ 3400	lm
Reverse Current	I _R	V _R = -7V	<0.05	μA

* Tolerance of measurements of the Forward Voltage is ± 0.05 V.

* Tolerance of measurements of the Luminous Flux is ± 5%.

Absolute Maximum Ratings (T_A= 25°C)

Item	Symbol	Absolute Maximum Rating	Unit
Forward Current	I _F	30	mA
*Pulse Forward Current	I _{FP}	100	mA
*Reverse Voltage	V _R	5	V
Power Dissipation	P _D	90	mW
Operating Temperature	T _{opr}	-40~+85	°C
Storage Temperature	T _{stg}	-40~+100	°C
Soldering Temperature	T _{sld}	Reflow Soldering : 260°C for 10sec Hand Soldering : 350°C for 3sec	
Junction Temperature	T _j	105	°C
Forward Voltage at Low Current	VF2	>1.9 (@1 μA)	V

* I_{FP} Conditions: Pulse Width ≤ 10msec, and duty ≤ 1/10

* Max condition is not guarantee for life time

Group Definition of Forward Voltage

Rank	Condition	VF(V)	
V7	T _A =25°C I _F =20mA	2.7	2.8
V8		2.8	2.9
V9		2.9	3.0

Group Definition of Brightness

Rank	Condition	Luminous Flux	
		I _v (mcd)	
		Min.	Max.
B7	T _A =25°C I _F =20mA	2700	2800
B8		2800	2900
B9		2900	3000
C0		3000	3100
C1		3100	3200
C2		3200	3300
C3		3300	3400

*A shipment shall consist of LEDs in a combination of above ranks.

* The percentage of each rank in the shipment shall be determined by AOT.

*The ranking information of LEDs can be found on the reel label.

Group Definition of Chromaticity Coordinate

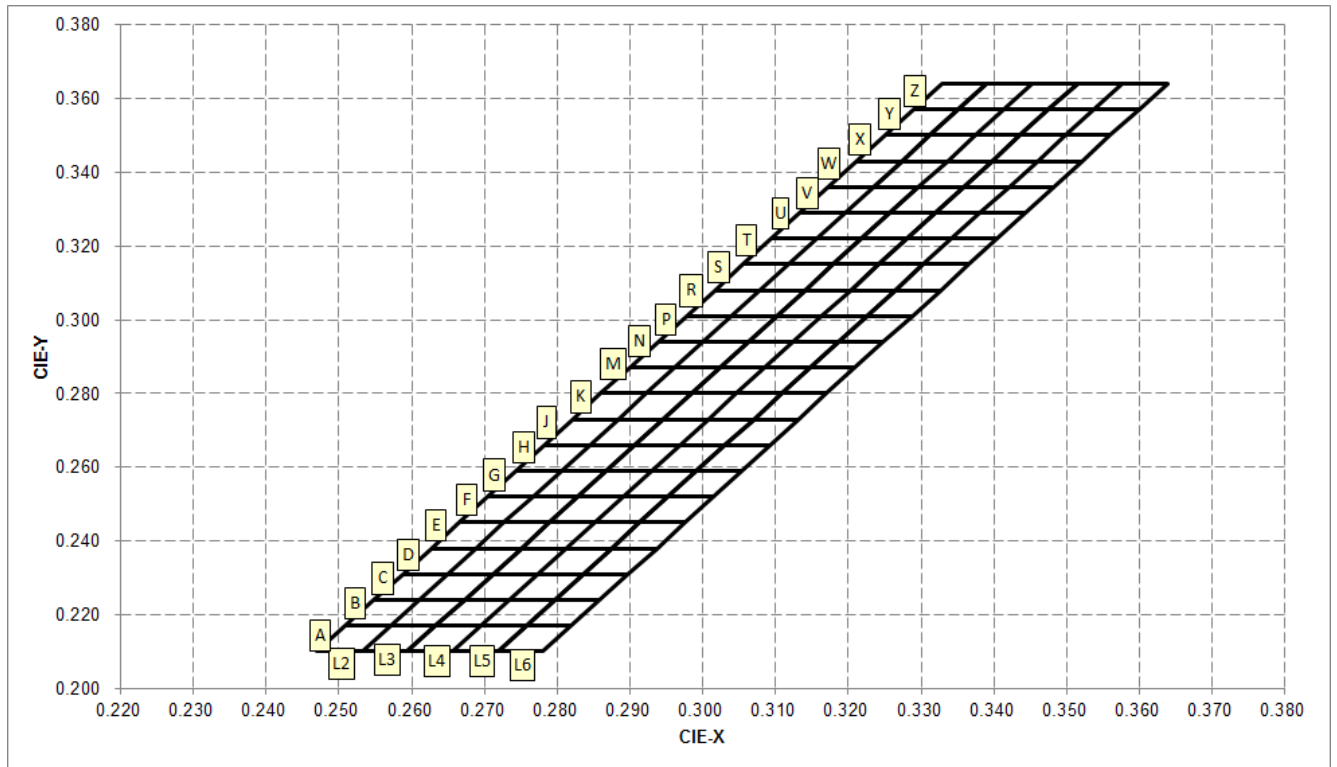

Rank	x	y	Rank	x	y	Rank	x	y
AL2	0.2470	0.2100	GL2	0.2704	0.2520	PL2	0.2938	0.2940
	0.2509	0.2170		0.2743	0.2590		0.2977	0.3010
	0.2571	0.2170		0.2805	0.2590		0.3039	0.3010
	0.2532	0.2100		0.2766	0.2520		0.3000	0.2940
BL2	0.2509	0.2170	HL2	0.2743	0.2590	RL2	0.2977	0.3010
	0.2548	0.2240		0.2782	0.2660		0.3016	0.3080
	0.2610	0.2240		0.2844	0.2660		0.3078	0.3080
	0.2571	0.2170		0.2805	0.2590		0.3039	0.3010
CL2	0.2548	0.2240	JL2	0.2782	0.2660	SL2	0.3016	0.3080
	0.2587	0.2310		0.2821	0.2730		0.3055	0.3150
	0.2649	0.2310		0.2883	0.2730		0.3117	0.3150
	0.2610	0.2240		0.2844	0.2660		0.3078	0.3080
DL2	0.2587	0.2310	KL2	0.2821	0.2730	TL2	0.3055	0.3150
	0.2626	0.2380		0.2860	0.2800		0.3094	0.3220
	0.2688	0.2380		0.2922	0.2800		0.3156	0.3220
	0.2649	0.2310		0.2883	0.2730		0.3117	0.3150
EL2	0.2626	0.2380	ML2	0.2860	0.2800	UL2	0.3094	0.3220
	0.2665	0.2450		0.2899	0.2870		0.3133	0.3290
	0.2727	0.2450		0.2961	0.2870		0.3195	0.3290
	0.2688	0.2380		0.2922	0.2800		0.3156	0.3220
FL2	0.2665	0.2450	NL2	0.2899	0.2870			
	0.2704	0.2520		0.2938	0.2940			
	0.2766	0.2520		0.3000	0.2940			
	0.2727	0.2450		0.2961	0.2870			

If color binning is required, only one color group is allowed for each chip within a reel.
 Chromaticity coordinate groups are measured with an accuracy of ± 0.005

Rank	x	y	Rank	x	y	Rank	x	y
AL3	0.2532	0.2100	GL3	0.2766	0.2520	PL3	0.3000	0.2940
	0.2571	0.2170		0.2805	0.2590		0.3039	0.3010
	0.2633	0.2170		0.2867	0.2590		0.3101	0.3010
	0.2594	0.2100		0.2828	0.2520		0.3062	0.2940
BL3	0.2571	0.2170	HL3	0.2805	0.2590	RL3	0.3039	0.3010
	0.2610	0.2240		0.2844	0.2660		0.3078	0.3080
	0.2672	0.2240		0.2906	0.2660		0.3140	0.3080
	0.2633	0.2170		0.2867	0.2590		0.3101	0.3010
CL3	0.2610	0.2240	JL3	0.2844	0.2660	SL3	0.3078	0.3080
	0.2649	0.2310		0.2883	0.2730		0.3117	0.3150
	0.2711	0.2310		0.2945	0.2730		0.3179	0.3150
	0.2672	0.2240		0.2906	0.2660		0.3140	0.3080
DL3	0.2649	0.2310	KL3	0.2883	0.2730	TL3	0.3117	0.3150
	0.2688	0.2380		0.2922	0.2800		0.3156	0.3220
	0.2750	0.2380		0.2984	0.2800		0.3218	0.3220
	0.2711	0.2310		0.2945	0.2730		0.3179	0.3150
EL3	0.2688	0.2380	ML3	0.2922	0.2800	UL3	0.3156	0.3220
	0.2727	0.2450		0.2961	0.2870		0.3195	0.3290
	0.2789	0.2450		0.3023	0.2870		0.3257	0.3290
	0.2750	0.2380		0.2984	0.2800		0.3218	0.3220
FL3	0.2727	0.2450	NL3	0.2961	0.2870			
	0.2766	0.2520		0.3000	0.2940			
	0.2828	0.2520		0.3062	0.2940			
	0.2789	0.2450		0.3023	0.2870			

If color binning is required, only one color group is allowed for each chip within a reel.
 Chromaticity coordinate groups are measured with an accuracy of ± 0.005

Rank	x	y	Rank	x	y	Rank	x	y
AL4	0.2594	0.2100	GL4	0.2828	0.2520	PL4	0.3062	0.2940
	0.2633	0.2170		0.2867	0.2590		0.3101	0.3010
	0.2695	0.2170		0.2929	0.2590		0.3163	0.3010
	0.2656	0.2100		0.2890	0.2520		0.3124	0.2940
BL4	0.2633	0.2170	HL4	0.2867	0.2590	RL4	0.3101	0.3010
	0.2672	0.2240		0.2906	0.2660		0.3140	0.3080
	0.2734	0.2240		0.2968	0.2660		0.3202	0.3080
	0.2695	0.2170		0.2929	0.2590		0.3163	0.3010
CL4	0.2672	0.2240	JL4	0.2906	0.2660	SL4	0.3140	0.3080
	0.2711	0.2310		0.2945	0.2730		0.3179	0.3150
	0.2773	0.2310		0.3007	0.2730		0.3241	0.3150
	0.2734	0.2240		0.2968	0.2660		0.3202	0.3080
DL4	0.2711	0.2310	KL4	0.2945	0.2730	TL4	0.3179	0.3150
	0.2750	0.2380		0.2984	0.2800		0.3218	0.3220
	0.2812	0.2380		0.3046	0.2800		0.3280	0.3220
	0.2773	0.2310		0.3007	0.2730		0.3241	0.3150
EL4	0.2750	0.2380	ML4	0.2984	0.2800	UL4	0.3218	0.3220
	0.2789	0.2450		0.3023	0.2870		0.3257	0.3290
	0.2851	0.2450		0.3085	0.2870		0.3319	0.3290
	0.2812	0.2380		0.3046	0.2800		0.3280	0.3220
FL4	0.2789	0.2450	NL4	0.3023	0.2870			
	0.2828	0.2520		0.3062	0.2940			
	0.2890	0.2520		0.3124	0.2940			
	0.2851	0.2450		0.3085	0.2870			

If color binning is required, only one color group is allowed for each chip within a reel.
 Chromaticity coordinate groups are measured with an accuracy of ± 0.005

Rank	x	y	Rank	x	y	Rank	x	y
AL5	0.2656	0.2100	GL5	0.2890	0.2520	PL5	0.3124	0.2940
	0.2695	0.2170		0.2929	0.2590		0.3163	0.3010
	0.2757	0.2170		0.2991	0.2590		0.3225	0.3010
	0.2718	0.2100		0.2952	0.2520		0.3186	0.2940
BL5	0.2695	0.2170	HL5	0.2929	0.2590	RL5	0.3163	0.3010
	0.2734	0.2240		0.2968	0.2660		0.3202	0.3080
	0.2796	0.2240		0.3030	0.2660		0.3264	0.3080
	0.2757	0.2170		0.2991	0.2590		0.3225	0.3010
CL5	0.2734	0.2240	JL5	0.2968	0.2660	SL5	0.3202	0.3080
	0.2773	0.2310		0.3007	0.2730		0.3241	0.3150
	0.2835	0.2310		0.3069	0.2730		0.3303	0.3150
	0.2796	0.2240		0.3030	0.2660		0.3264	0.3080
DL5	0.2773	0.2310	KL5	0.3007	0.2730	TL5	0.3241	0.3150
	0.2812	0.2380		0.3046	0.2800		0.3280	0.3220
	0.2874	0.2380		0.3108	0.2800		0.3342	0.3220
	0.2835	0.2310		0.3069	0.2730		0.3303	0.3150
EL5	0.2812	0.2380	ML5	0.3046	0.2800	UL5	0.3280	0.3220
	0.2851	0.2450		0.3085	0.2870		0.3319	0.3290
	0.2913	0.2450		0.3147	0.2870		0.3381	0.3290
	0.2874	0.2380		0.3108	0.2800		0.3342	0.3220
FL5	0.2851	0.2450	NL5	0.3085	0.2870			
	0.2890	0.2520		0.3124	0.2940			
	0.2952	0.2520		0.3186	0.2940			
	0.2913	0.2450		0.3147	0.2870			

If color binning is required, only one color group is allowed for each chip within a reel.
 Chromaticity coordinate groups are measured with an accuracy of ± 0.005

Rank	x	y	Rank	x	y	Rank	x	y
AL6	0.2718	0.2100	FL6	0.2913	0.2450	ML6	0.3108	0.2800
	0.2757	0.2170		0.2952	0.2520		0.3147	0.2870
	0.2819	0.2170		0.3014	0.2520		0.3209	0.2870
	0.2780	0.2100		0.2975	0.2450		0.3170	0.2800
BL6	0.2757	0.2170	GL6	0.2952	0.2520	NL6	0.3147	0.2870
	0.2796	0.2240		0.2991	0.2590		0.3186	0.2940
	0.2858	0.2240		0.3053	0.2590		0.3248	0.2940
	0.2819	0.2170		0.3014	0.2520		0.3209	0.2870
CL6	0.2796	0.2240	HL6	0.2991	0.2590	PL6	0.3186	0.2940
	0.2835	0.2310		0.3030	0.2660		0.3225	0.3010
	0.2897	0.2310		0.3092	0.2660		0.3287	0.3010
	0.2858	0.2240		0.3053	0.2590		0.3248	0.2940
DL6	0.2835	0.2310	JL6	0.3030	0.2660	RL6	0.3225	0.3010
	0.2874	0.2380		0.3069	0.2730		0.3264	0.3080
	0.2936	0.2380		0.3131	0.2730		0.3326	0.3080
	0.2897	0.2310		0.3092	0.2660		0.3287	0.3010
EL6	0.2874	0.2380	KL6	0.3069	0.2730	SL6	0.3264	0.3080
	0.2913	0.2450		0.3108	0.2800		0.3303	0.3150
	0.2975	0.2450		0.3170	0.2800		0.3365	0.3150
	0.2936	0.2380		0.3131	0.2730		0.3326	0.3080
TL6	0.3303	0.3150	UL6	0.3342	0.3220	VL6	0.3381	0.3290
	0.3342	0.3220		0.3381	0.3290		0.3420	0.3360
	0.3404	0.3220		0.3443	0.3290		0.3482	0.3360
	0.3365	0.3150		0.3404	0.3220		0.3443	0.3290
WL6	0.3420	0.3360	XL6	0.3459	0.3430	YL6	0.3498	0.3500
	0.3459	0.3430		0.3498	0.3500		0.3537	0.3570
	0.3521	0.3430		0.3560	0.3500		0.3599	0.3570
	0.3482	0.3360		0.3521	0.3430		0.3560	0.3500
ZL6	0.3537	0.3570						
	0.3576	0.3640						
	0.3638	0.3640						
	0.3599	0.3570						

If color binning is required, only one color group is allowed for each chip within a reel.
 Chromaticity coordinate groups are measured with an accuracy of ± 0.005

Optical and electrical characteristics

Forward Voltage vs. Forward Current (Ta=25°C)

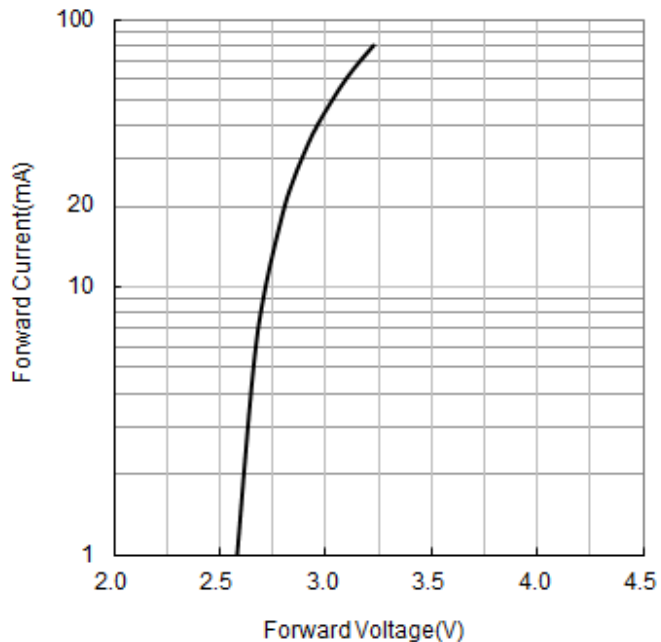

Forward Current vs. Relative Luminous Flux (Ta=25°C)

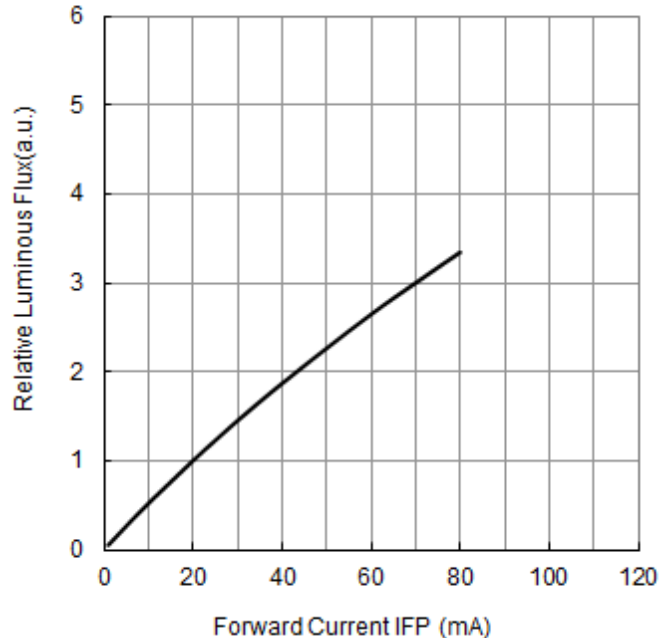

Ambient Temperature vs. Forward Voltage

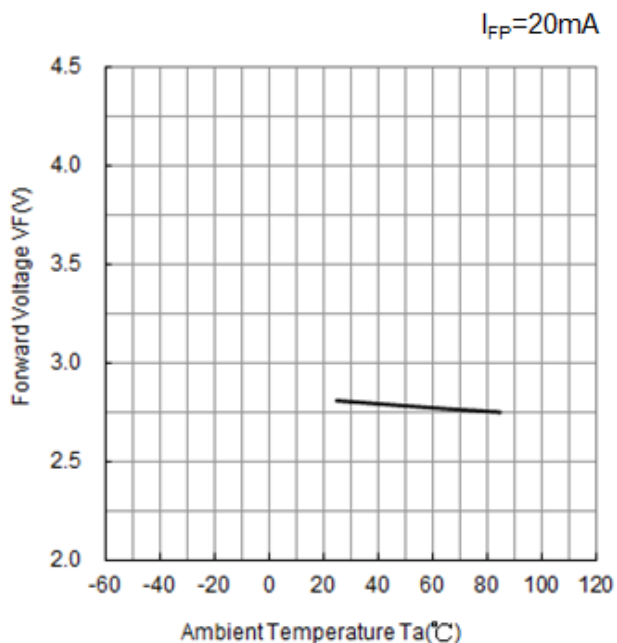

Ambient Temperature vs. Relative Luminous

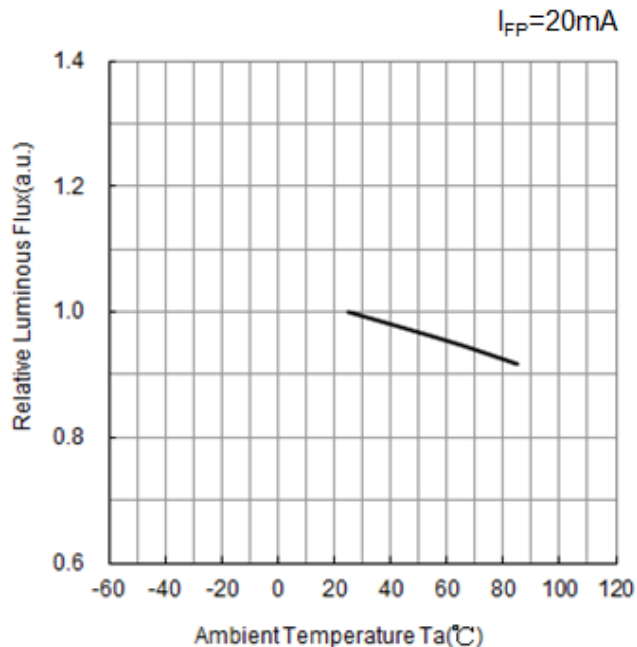

Forward Current vs. Chromaticity Coordinate ($T_A=25^\circ\text{C}$)

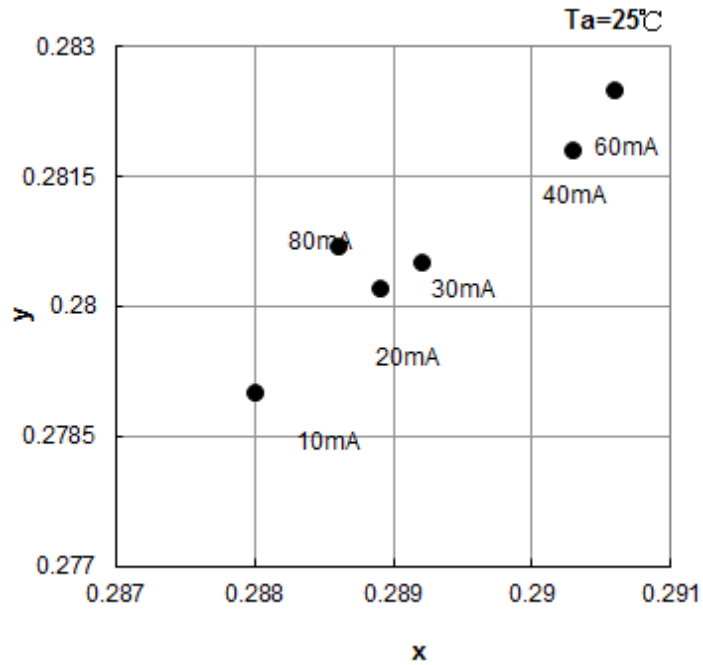

Ambient Temperature vs. Chromaticity Coordinate ($I_{FP}=20\text{mA}$)

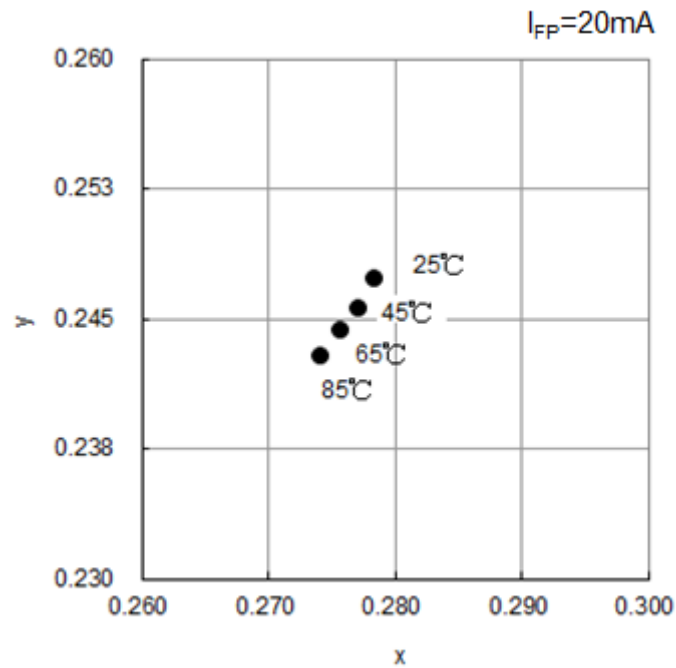

Spectrum($T_A=25^{\circ}\text{C}$, $I_{FP}=20\text{mA}$)

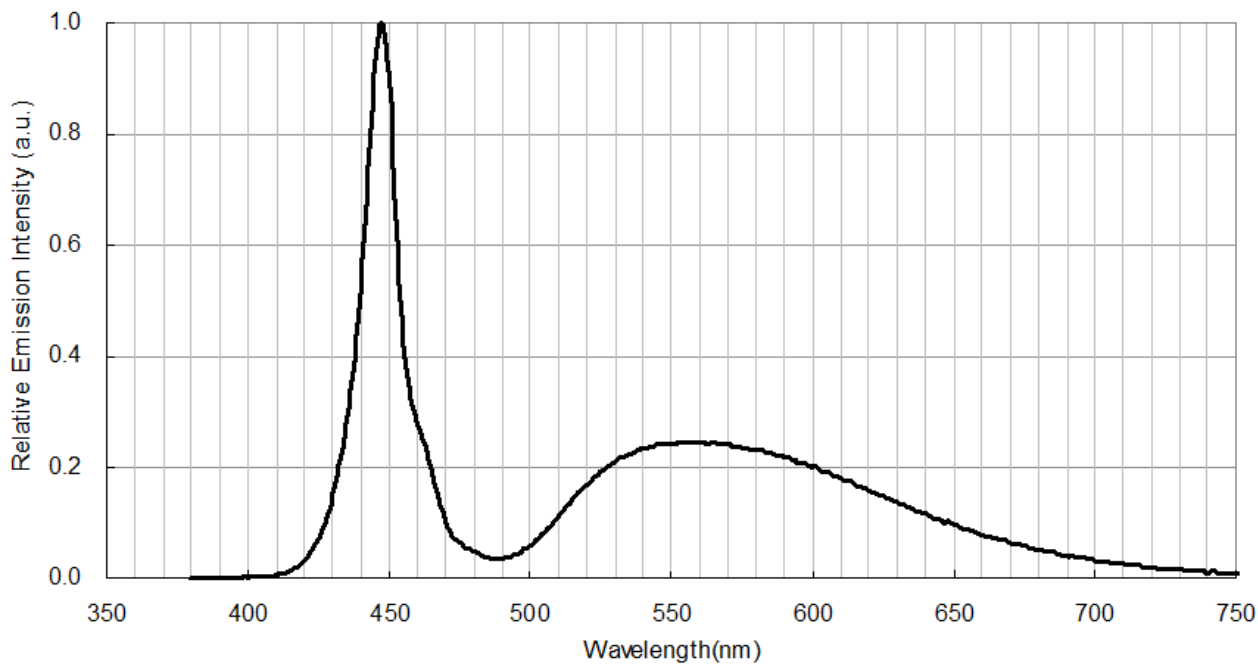

Radiation Pattern($T_A=25^{\circ}\text{C}$, $I_{FP}=20\text{mA}$)

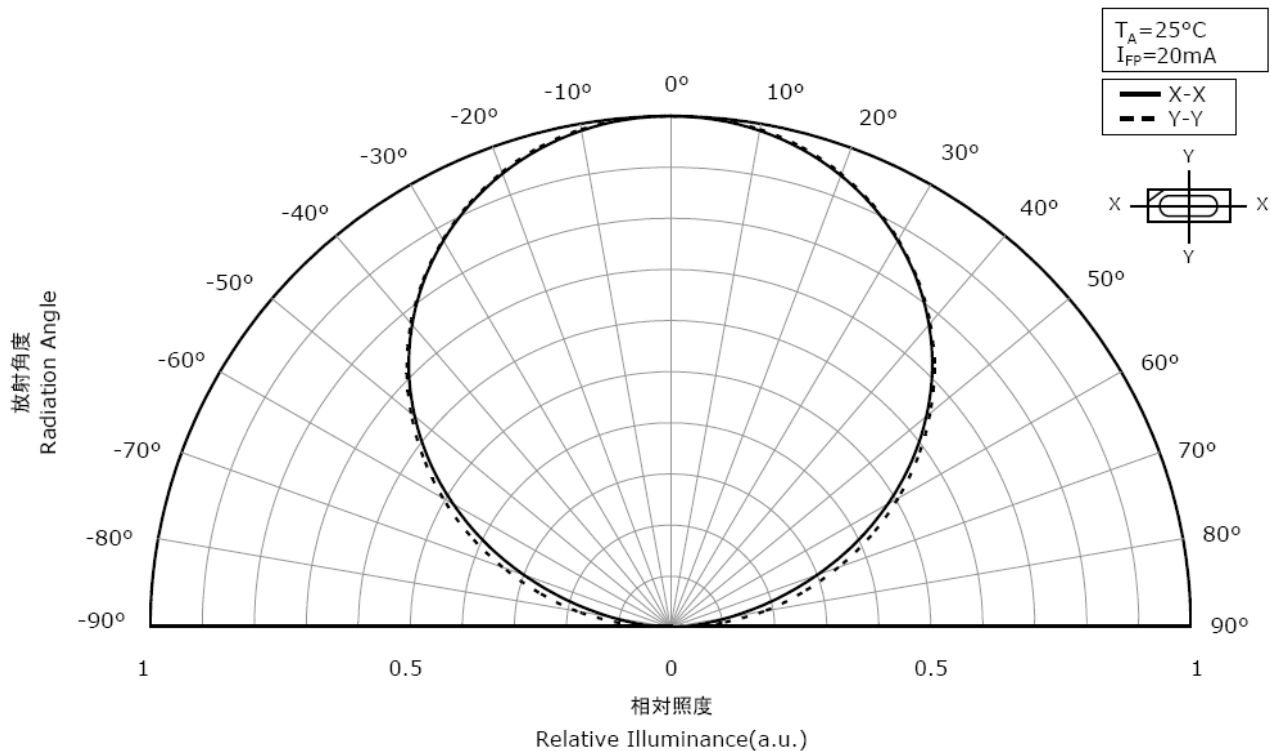

Recommended Reflow Soldering Conditions

Surface Mounting Condition

In automatic mounting of the SMD LEDs on printed circuit boards, any bending, expanding and pulling forces or shock against the SMD LEDs should be kept min. to prevent them from electrical failures and mechanical damages of the devices.

Soldering Reflow

- Soldering of the SMD LEDs should conform to the soldering condition in the individual specifications.
- SMD LEDs are designed for Reflow Soldering.
- In the reflow soldering, too high temperature and too large temperature gradient such as rapid heating/cooling may cause electrical & optical failures and damages of the devices.
- AOT cannot guarantee the LEDs after they have been assembled using the solder dipping method.

1) Lead Solder

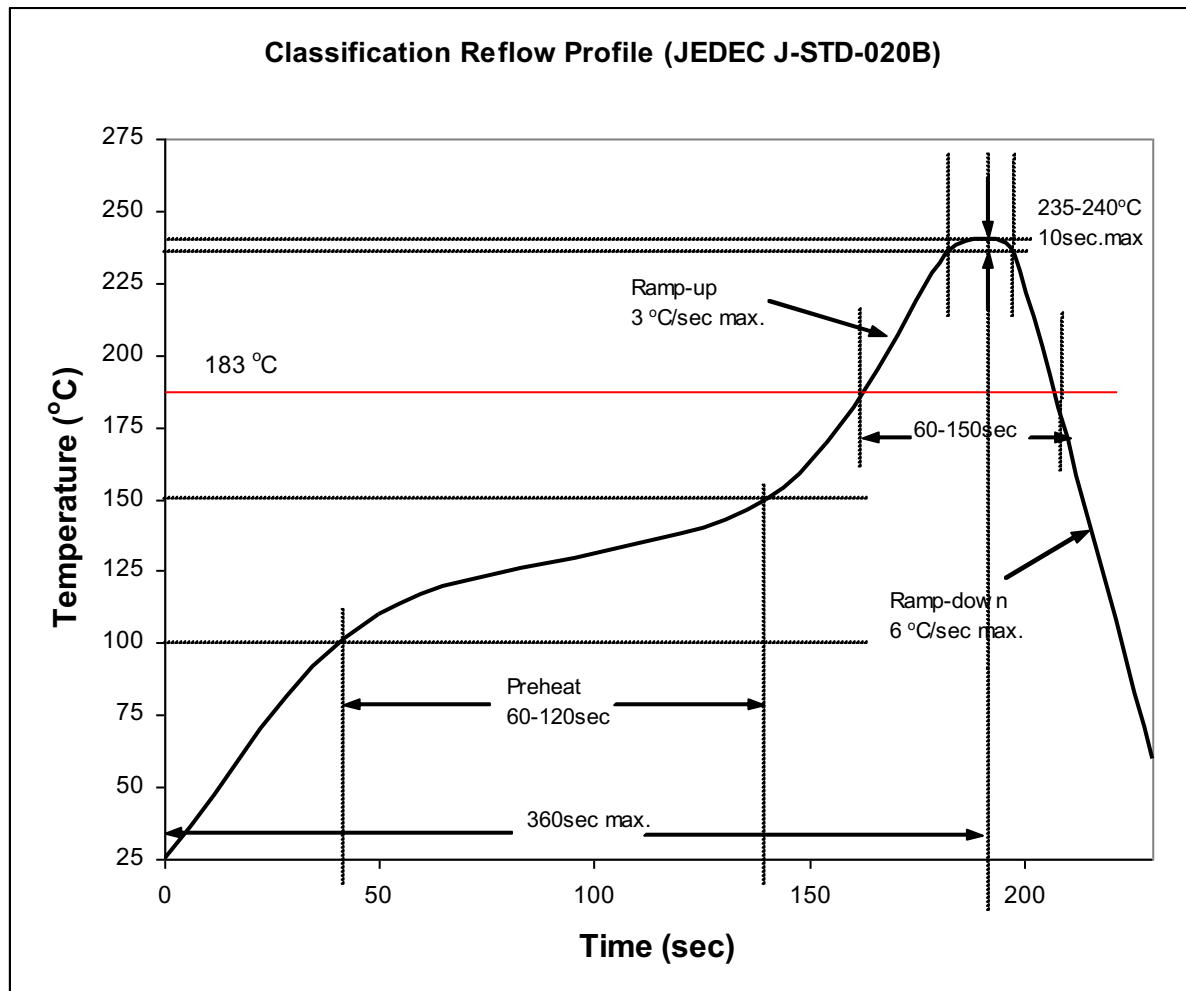

2) Lead-Free Solder

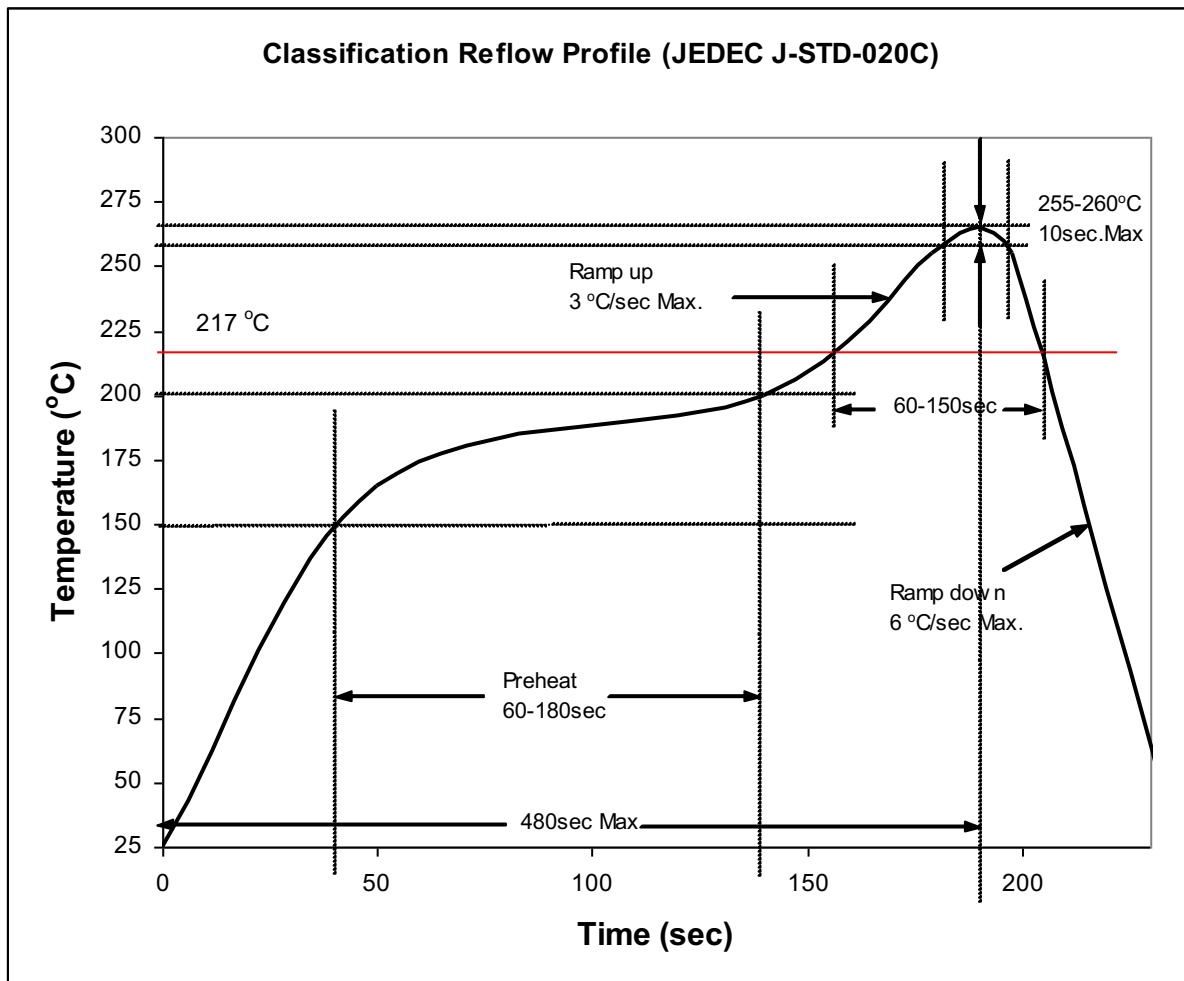

3) Manual Soldering Conditions

- Lead Solder

Max. 300 °C for Max. 3sec, and only one time.

- Lead-free Solder

Max. 350 °C for Max. 3sec, and only one time.

- There is possibility that the brightness of LEDs is decreased, which is influenced by heat or ambient atmosphere during reflow. It is recommended to use the nitrogen reflow method.
- After LEDs have been soldered, repair should not be done. As repair is unavoidable, a double-head soldering iron should be used. It should be confirmed beforehand whether the characteristics of the LEDs will be damaged by repairing or not.
- Reflow soldering should not be done more than two times.

Dimensions (Unit :mm)

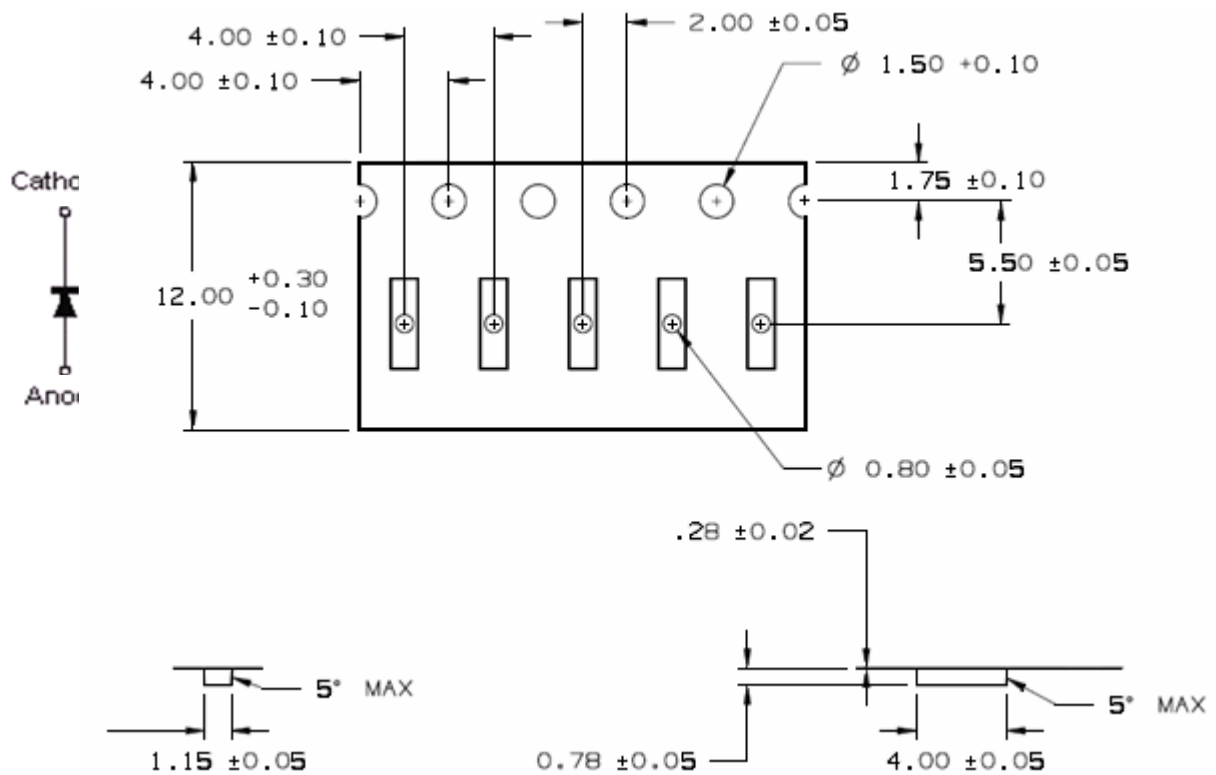

Item	Spec.	Tolerance(mm)	Item	Spec.	Tolerance(mm)
W	12.0	+0.30/-0.10	P2	2.00	±0.05
E	1.75	±0.10	P0x10	40.0	-
F	5.50	±0.05	t	0.28	±0.05
D0	1.50	±0.10	A0	1.15	±0.05
D1	0.8	±0.10	B0	4.0	±0.05
P0	4.00	±0.10	K0	0.78	±0.05
P1	4.00	±0.10			

Packing Formation

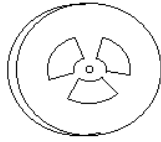

Diameter : 178 mm
 Width : 8 mm
 3806C-W3CZ
 ⇒ 4,000 pcs/Reel

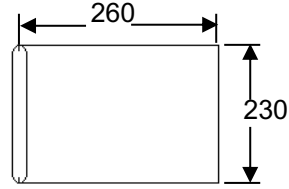
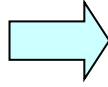

Aluminum Bag, Anti-Static Shielding
 1 Reel / Bag (T = 0.1 mm)

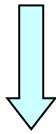

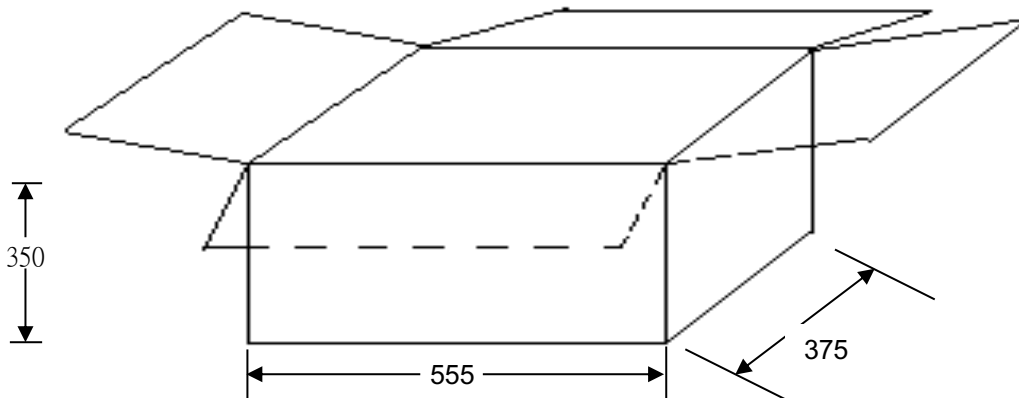

90 Aluminum Bag/1 Carton
 360,000 pcs/ 1Carton



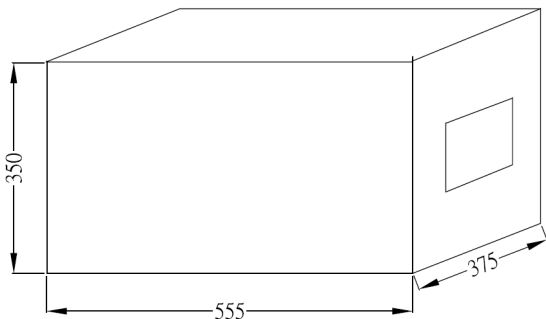

Package Outlook:



 Solid-State Light. Done Right. Advanced Optoelectronic Technology Inc.	
Customer	
PO No.	
Part No.	
Quantity	
Packing Date	
Carton No.	
Ship No.	
QC Check	 
備註	

Reel Label Definition

SMD LED	SAP. No.
Part Number : XXXXX-XXXX	
Brightness : A	
CIE : B	
VF : C	
Quantity : nn ea	
Serial No : SM0yymmddxxxx	
	
Cust. PN. : XXXXX-XXXX	

A : Iv value noted,
B : CIE value noted,
C : Vf value noted,
nn : Quantity of LED

SM0yymmddxxxx : yy : year, mm : month, dd : day, xxx : reel no

*Reel Label to fill in practice data of all LED characteristic

Reliability Test

No.	Test Item	Standard Test Method	Test Condition	Note	Number of Damaged
1	Room Temp. Life Test	Internal Ref.	$T_A=25^{\circ}\text{C}, I_F=20\text{mA}$	1000hrs	0/20
2	High Temp. Operating	JESD22-A108	$T_A=65^{\circ}\text{C}, I_F=20\text{mA}$	1000hrs	0/20
3	High Temp. Operating	JESD22-A108	$T_A=85^{\circ}\text{C}, I_F=8.5\text{mA}$	1000hrs	0/20
4	High Temp. Storage	JESD22-A103	$T_A=100^{\circ}\text{C}$	1000hrs	0/20
5	Low Temp. Operating	JESD22-A108	$T_A=-40^{\circ}\text{C}, I_F=20\text{mA}$	1000hrs	0/20
6	High Temp. and High Humidity Operation	JESD22-A119	$60^{\circ}\text{C} \ 95\%\text{RH}, I_F=20\text{mA}$	1000hrs	0/20
7	Temperature and humidity cycle test	IEC68-2-38	$25^{\circ}\text{C} \sim 65^{\circ}\text{C} \sim -10^{\circ}\text{C}, 90\% \text{RH}$ 24hr per cycle	10 cycle	0/20
8	Thermal Cycle Test	JESD22-A106	$100^{\circ}\text{C} \ 30\text{min} \sim -40^{\circ}\text{C} \ 30\text{min}$ Transform time 5min	300cycles	0/20

Criteria for Judging Damage

Item	Symbol	Test Conditions	Criteria for Judgement	
			Min.	Max.
Forward Voltage	V_F	$I_F=20\text{mA}$	-	*U.S.L \times 1.1
Reverse Current	I_R	$V_R=5\text{V}$	-	*U.S.L \times 2.0
Luminous Intensity	I_v	$I_F=20\text{mA}$	*L.S.L \times 0.7	-

* U.S.L: Upper Standard Level

* L.S.L: Lower Standard Level

Side View Process Flow

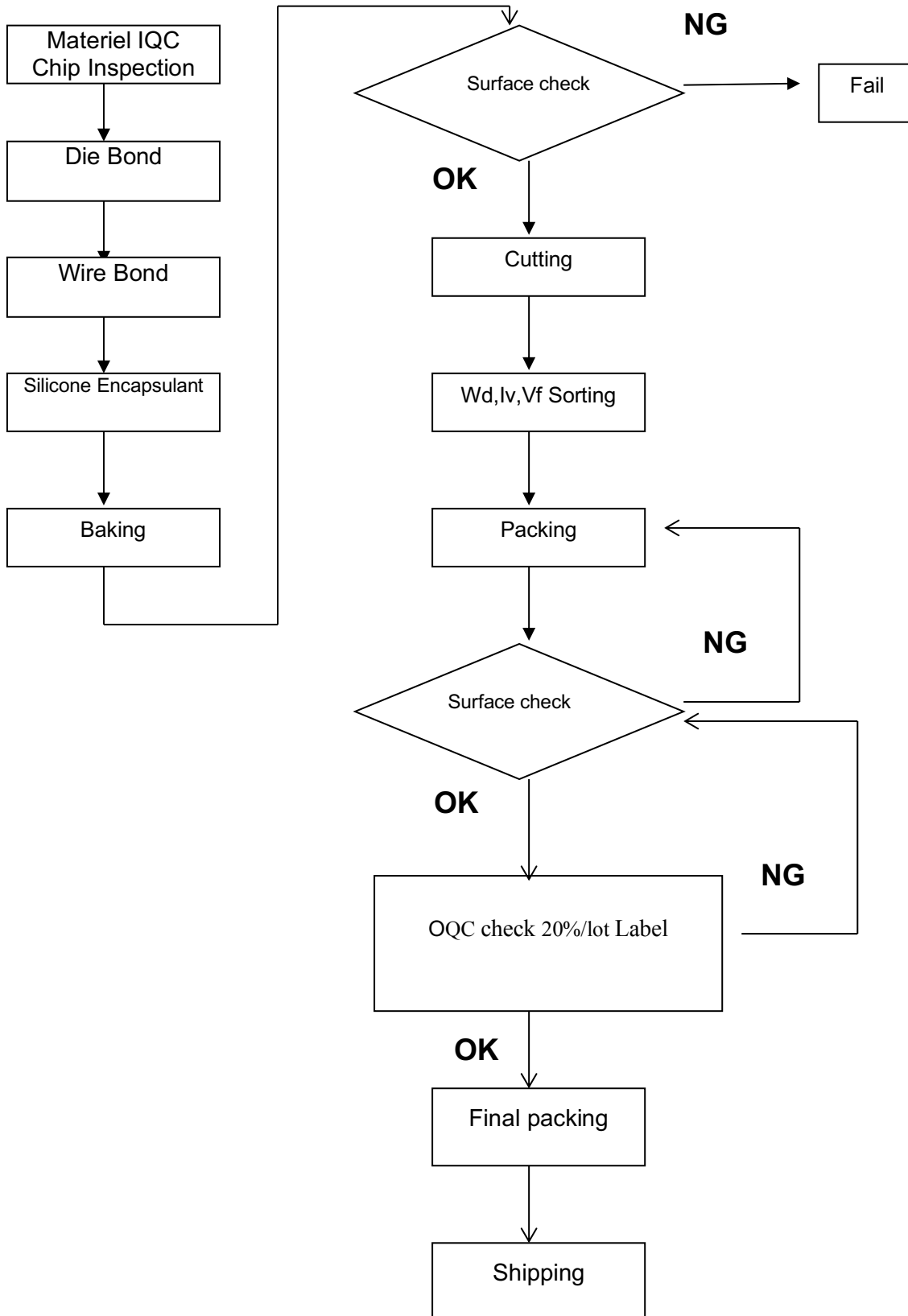

CAUTIONS

(1) Moisture Proof Package

The moisture proof package should be used to prevent moisture in the package as the moisture may cause damage to optical characteristics of the LEDs.

The aluminum bag with zipper is used for moisture proof package. And, the moisture absorbent material, Silica gel, is inserted into aluminum bag.

(2) Storage:

Storage Conditions

Before opening the package:

The LEDs should be kept at 30°C or less than 90%RH or less. The LEDs should be used within a year. When storing the LEDs, moisture proof packaging with absorbent material is recommended.

After opening the package:

After open the package, the LED should be kept at 30°C, 60%RH or less. The LED should be soldered within 168 hours (7 days) after opening the package. If unused LEDs remain, it should be stored in moisture proof condition.

(3) Heat Generation

Thermal design of the end products is of paramount importance. The heat generation must be taken into design consideration when using the LED. The coefficient of the temperature increase per input electric power is affected by the thermal resistance of the circuit board and density of LED placement on the board, as well as other components.

(4) Static Electricity

Static electricity or surge voltage damages the LEDs. All equipment and machinery must be properly grounded. It is recommended to use a wristband or anti-electrostatic glove when handling the LEDs. When inspecting the final products in which LEDs were assembled, it is recommended to check whether the assembled LEDs are damaged by static electricity or not. It is easy to find static-damaged LEDs by a light-on test or a Vf test at a lower current. (Below 1mA is recommended).

Criteria: $V_f > 1.9V$ at $I_f = 1 \mu A$

(5) Cleaning

Use isopropyl alcohol as a solvent for cleaning the LEDs. The other solvent may dissolve the LEDs package and the epoxy.

Ultrasonic cleaning should not be done.

(6) Electrostatic Discharge (ESD)

The products are sensitive to static electricity or surge voltage, An ESD event may damage its die or reduce its reliability performance. When handling the products, measures against electro static discharge, including the followings, are strongly recommended.

Eliminating the charge;

Wrist strap, ESD footwear and garments, ESD floors

Grounding the equipment and tools at workstation

ESD table / shelf mat (conductive materials)

Proper grounding techniques are required for all devices, equipment and machinery used in the assembly of the products, Also note that surge protection should be considered in the design of customer products.

If tools or equipment contain insulating materials, such as glass or plastic, proper measures against



Solid-State Light. Done Right.

electro static discharge, including the followings are strongly recommended.

Dissipating the charge with conductive materials

Preventing the charge generation with moisture

Neutralizing the charge with ionizer

(7) Others

When using the LEDs, it must care that the reverse voltage will not exceed the absolute maximum rating. The LED light is enough to injure human eyes, so it should avoid looking at LED light directly.

NOTE.

All the information published is considered to be reliable. However, AOT does not assume any liability arising out of the application or use of any product described herein.

AOT reserves the right to make changes at any time without notice to any products in order to improve reliability, function or design.

AOT products are not authorized for use as critical components in life support devices or systems without the express written approval from the managing director of AOT.