

APPROVAL SHEET

AOT MODEL NAME	3433
AOT PART NUMBER	3433C-R001
CUSTOMER NAME	General
DATE	2021 / Apr.
VERSION	01

MAKER			CUSTOMER			
Prepared	Checked	Approved				
<i>Jinwen Lo</i>	<i>Sunway Yeh</i>	<i>Houde Lin</i>				

TENTATIVE

AOT Headquarters
No. 13, Gongye 5th. Road, Hsinchu Industrial Park, Hukou Shiang,
Hsinchu Hsien 303, Taiwan, R.O.C.
TEL: +886-3-597-6988 / FAX: +886-3-598-7392

Package Outline

Model name: 3433C-R001

Unit: mm, Tolerance: ± 0.2 mm

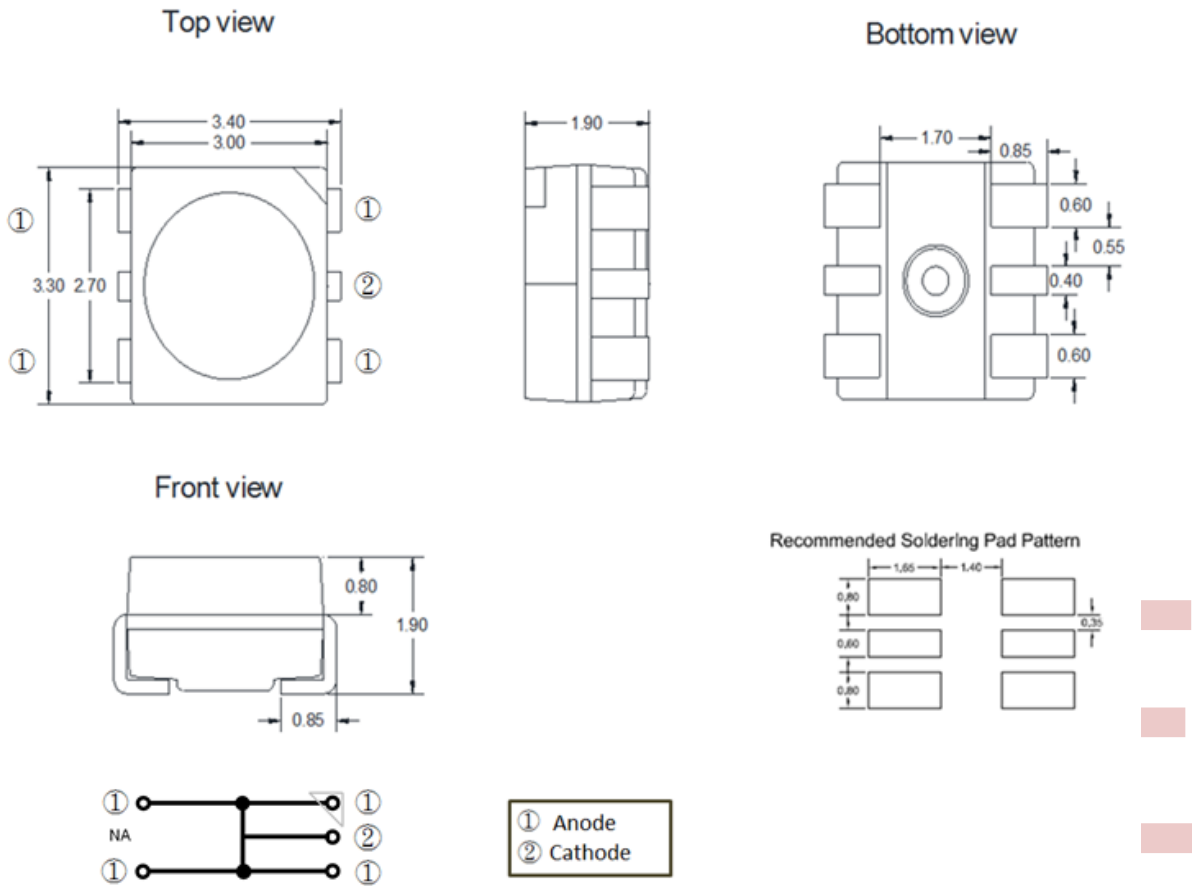

Item	Materials
Package	Heat-Resistant Polymer
Encapsulating Material	Silicone
Electrode	Ni , Pd , Au Plating Copper Alloy

- Single red chip.
- Compact package outline (LxWxH) of 3.4 mm x 3.3 mm x 1.9 mm.
- Compatible with reflow soldering.
- Complies with RoHS Directive.

Optical/Electronic Characteristics (T_s=25°C)

AOT Reading Standards						
Item	Symbol	Condition	Min	Typ.	Max	Unit
Forward Voltage	V _F	I _F = 150mA	1.75	-	2.75	V
Luminous Intensity	φ _v	I _F = 150mA	5600	-	11200	mcd
Dominant Wavelength	λ _d	I _F = 150mA	612		624	nm
Thermal Resistance	R _{ths-j}		-	26	-	°C/W

- * Tolerance of measurements of the Forward Voltage is ± 0.05 V.
- * Tolerance of measurements of the Luminous Intensity is ± 7%.
- * Tolerance of measurements of the Dominant Wavelength is ± 1nm.

Absolute Maximum Ratings (T_s=25°C)

Item	Symbol	Absolute Maximum Rating	Unit
Forward Current	I _F	200	mA
Power Dissipation	P _D	520	mW
Reverse Voltage	V _R	5	V
Operating Temperature	T _{opr}	-40~+85	°C
Storage Temperature	T _{stg}	-40~+85	°C
Soldering Temperature	T _{sld}	Reflow Soldering : 260°C for 10sec Hand Soldering : 350°C for 3sec	
Junction Temperature	T _j	115	°C
Forward Voltage at Low Current	V _{F2}	>0.9 (@1uA)	V

- * Max condition is not guarantee for life time

Group Definition of Forward Voltage

Rank	Condition	V _F (V)
1720	T _s =25°C I _F =150mA	1.75 ~ 2.0
2022		2.0 ~ 2.25
2225		2.25 ~ 2.50
2527		2.50 ~ 2.75

Group Definition of Brightness

Rank	Condition	Luminous Intensity(mcd)
DB	T _s =25°C I _F =150mA	5600 ~ 7100
EA		7100 ~ 9000
EB		9000 ~ 11200

Group Definition of Dominant Wavelength

Rank	Condition	Dominant Wavelength (nm)
1215	T _s =25°C I _F =150mA	612 ~ 615
1518		615 ~ 618
1831		618 ~ 621
2124		621 ~ 624

*A shipment shall consist of LEDs in a combination of above ranks.

The percentage of each rank in the shipment shall be determined by AOT.

*The ranking information of LEDs can be found on the reel label.

Recommended Reflow Soldering Conditions

Surface Mounting Condition

In automatic mounting of the SMD LEDs on printed circuit boards, any bending, expanding and pulling forces or shock against the SMD LEDs should be kept min. to prevent them from electrical failures and mechanical damages of the devices.

Soldering Reflow

-Soldering of the SMD LEDs should conform to the soldering condition in the individual specifications.

-SMD LEDs are designed for Reflow Soldering.

-In the reflow soldering, too high temperature and too large temperature gradient such as rapid heating/cooling may cause electrical & optical failures and damages of the devices.

-AOT cannot guarantee the LEDs after they have been assembled using the solder dipping method.

1) Lead Solder

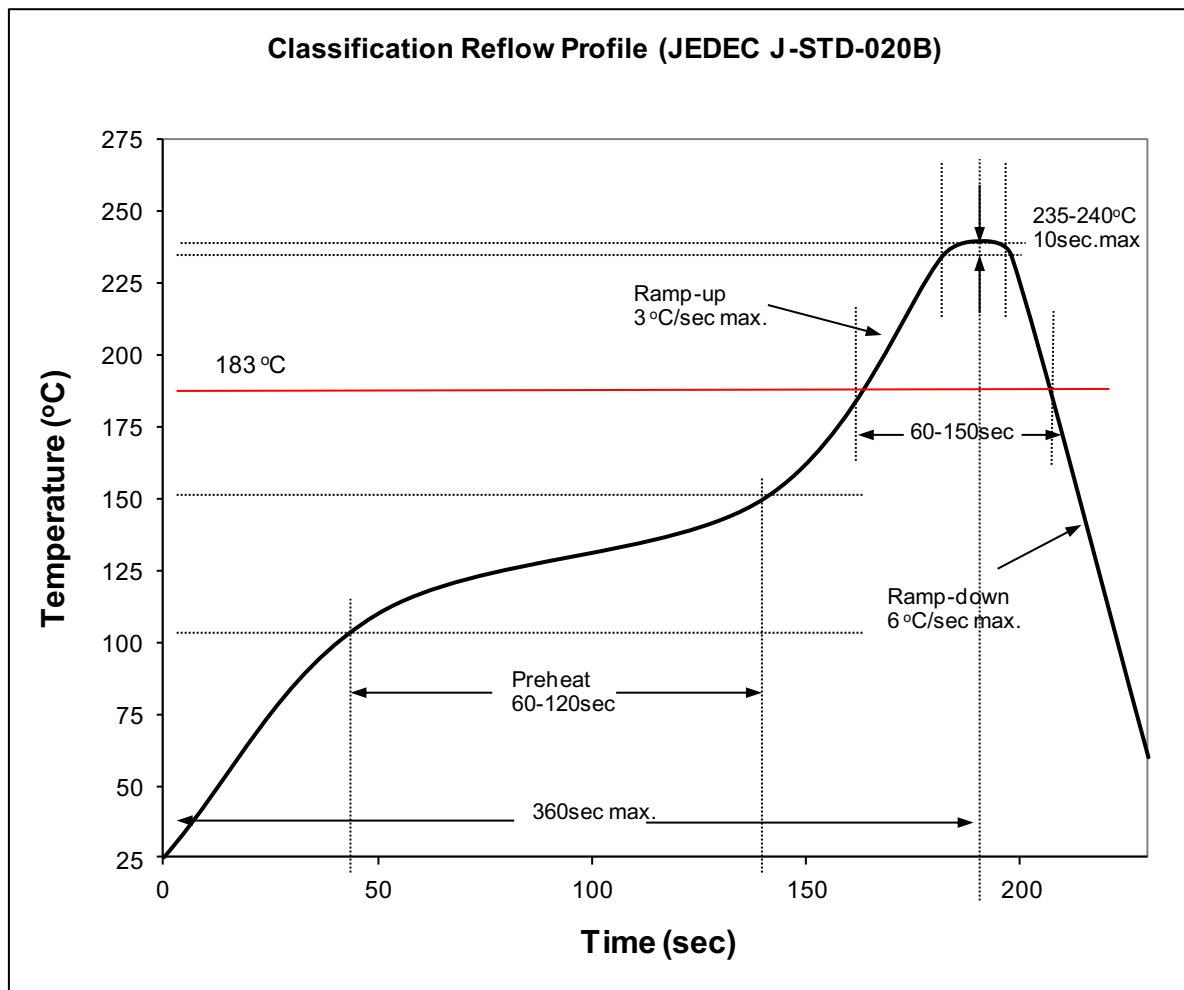

2) Lead-Free Solder

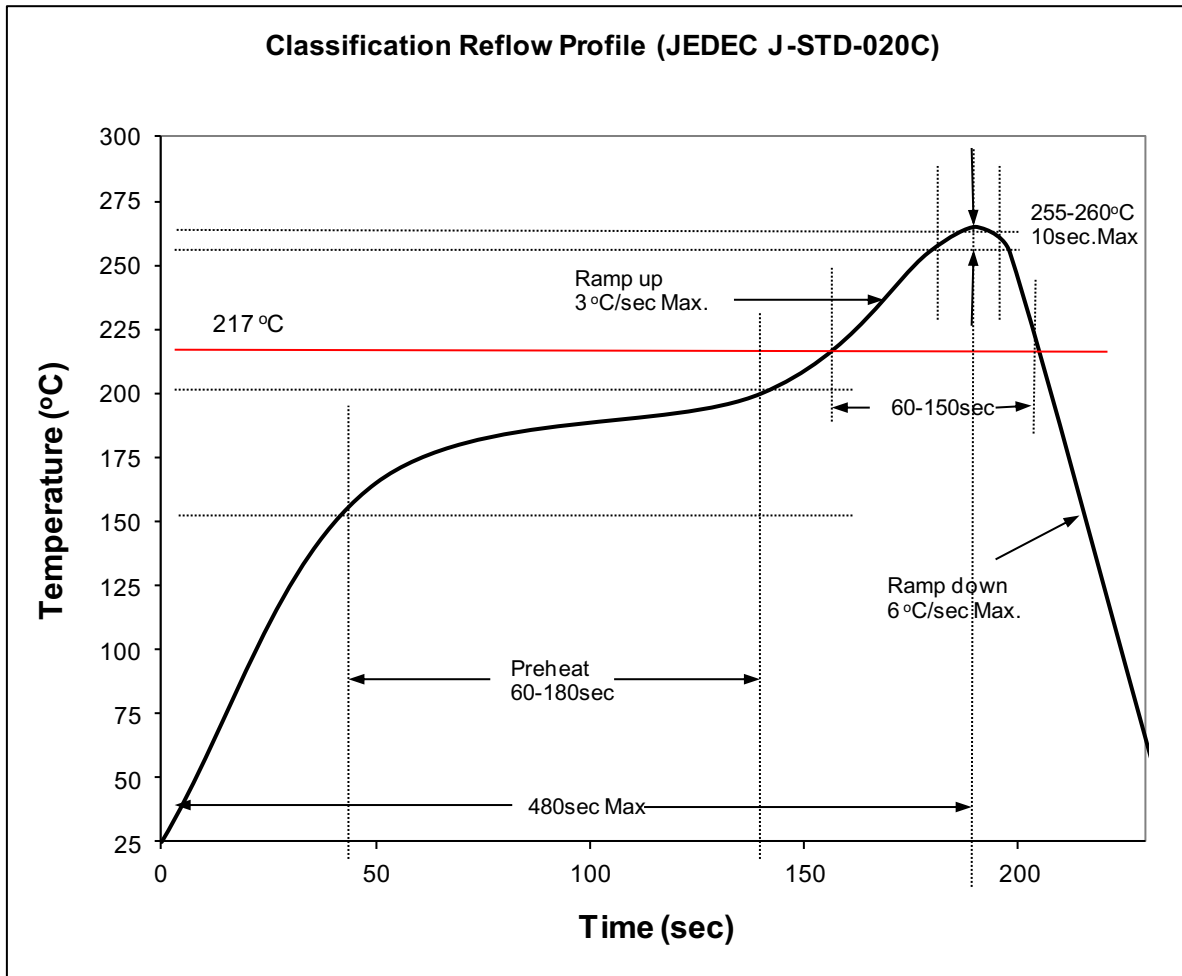

3) Manual Soldering Conditions

- Lead Solder

Max. 300 °C for Max. 3sec, and only one time.

- Lead-free Solder

Max. 350 °C for Max. 3sec, and only one time.

- There is possibility that the brightness of LEDs is decreased, which is influenced by heat or ambient atmosphere during reflow. It is recommended to use the nitrogen reflow method.

- After LEDs have been soldered, repair should not be done. As repair is unavoidable, a double-head soldering iron should be used. It should be confirmed beforehand whether the characteristics of the LEDs will be damaged by repairing or not.

- Reflow soldering should not be done more than two times.

Dimensions (Unit :mm)

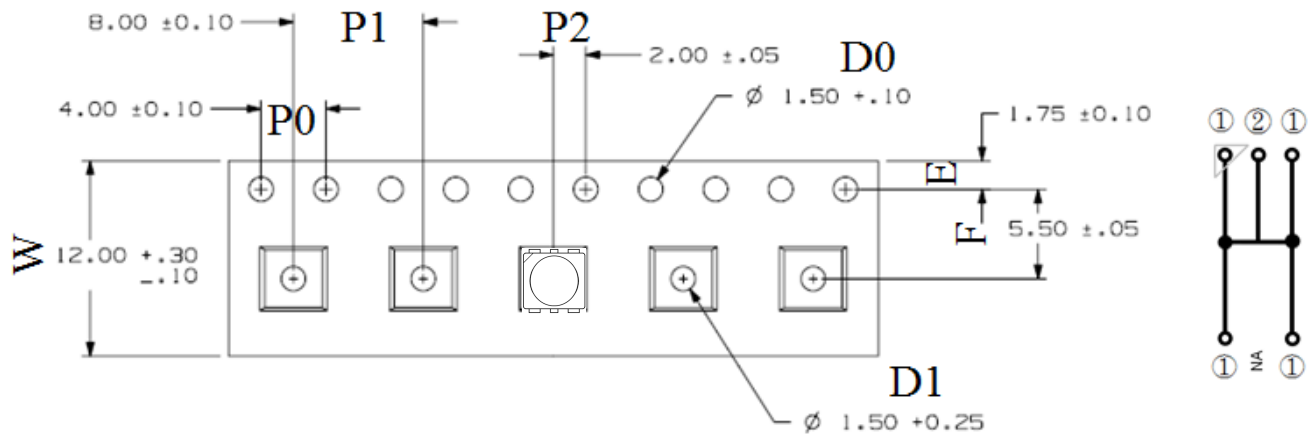

- ① Anode
- ② Cathode

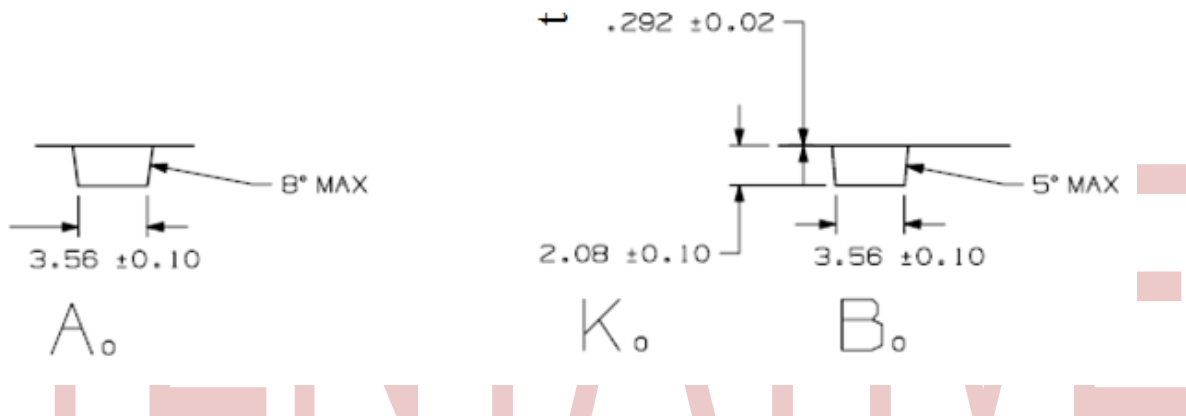

Item	Spec.	Tolerance(mm)	Item	Spec.	Tolerance(mm)
W	12.00	+0.3,-0.1	P1	8.00	±0.10
E	1.75	±0.10	P2	2.00	±0.05
F	5.50	±0.05	t	0.292	±0.02
D0	1.50	+0.10	A0	3.56	±0.10
D1	1.50	+0.25	B0	3.56	±0.10
P0	4.00	±0.10	K0	2.08	±0.10

Packing Formation

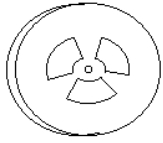

Diameter : 178 mm
 Width : 12 mm
 1,000 pcs/Reel
 Antistatic Reel

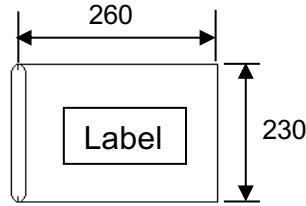
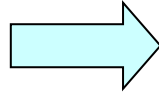

MBB Bag
 +5g drying agent
 +Humidity card
 1 Reel / Bag

50 Bags / 1 Carton
 ⇒ 50,000 pcs/ 1Carton

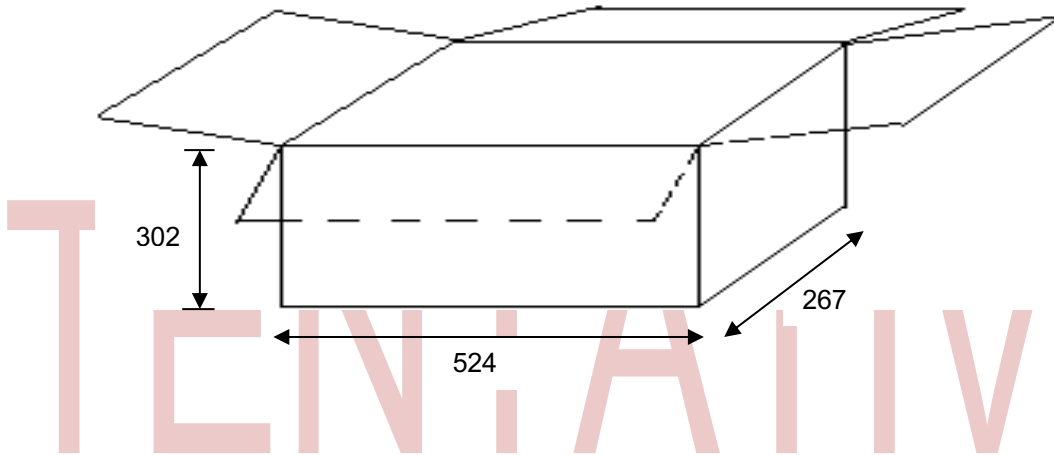
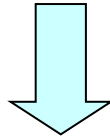

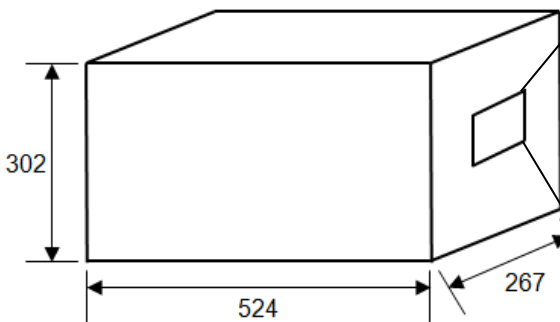

Package Outlook



 Solid-State Light. Done Right. Advanced Optoelectronic Technology Inc.	
Customer	
PO No.	
Part No.	
Quantity	
Packing Date	
Carton No.	
Ship No.	
QC Check	
備註	

Reel Label Definition

SMD LED		SAP. No.
Part Number	: XXXXX-XXXX	
Brightness	: A	
WD	: B	
VF	: C	
Quantity	: nn ea	
Serial No	: SM0yymmddxxxx	
		
Cust. PN.	: XXXXX-XXXX	

A : Iv value.
B : WD value noted
C : Vf value.
nn : Quantity of LED

SM0yymmddxxx : yy : year, mm : month, dd : day, xxxx : reel no.

*Reel Label to fill in practice data of all LED characteristic

TENTATIVE

Cautions

(1) Moisture Proof Package

The moisture proof package should be used to prevent moisture in the package as the moisture may Cause damage to optical characteristics of the LEDs.

The aluminum bag with zipper is used for moisture proof package. And, the moisture absorbent Material, Silica gel, is inserted into aluminum bag.

(2) Storage:

Storage Conditions

Before opening the package:

The LEDs should be kept at 30°C or less than 90%RH or less. The LEDs should be used within a year. When storing the LEDs, moisture proof packaging with absorbent material is recommended.

After opening the package:

After open the package, the LED should be kept at 30°C, 60%RH or less. The LED should be soldered within 168 hours (7 days) after opening the package. If unused LEDs remain, it should be stored in moisture proof condition.

(3) Heat Generation

Thermal design of the end products is of paramount importance. The heat generation must be taken into design consideration when using the LED. The coefficient of the temperature increase per input electric power is affected by the thermal resistance of the circuit board and density of LED placement on the board, as well as other components.

(4) Static Electricity

Static electricity or surge voltage damages the LEDs. All equipment and machinery must be properly grounded. It is recommended to use a wristband or anti-electrostatic glove when handling the LEDs. When inspecting the final products in which LEDs were assembled, it is recommended to check whether the assembled LEDs are damaged by static electricity or not. It is easy to find static-damaged LEDs by a light-on test or a Vf test at a lower current. (Below 1mA is recommended).

Criteria: $V_F > 0.9V$ at $I_F = 1\mu A$

(5) Cleaning

Use isopropyl alcohol as a solvent for cleaning the LEDs. The other solvent may dissolve the LEDs package and the epoxy.

Ultrasonic cleaning should not be done.

(6) Electrostatic Discharge (ESD)

The products are sensitive to static electricity or surge voltage, An ESD event may damage its die or reduce its reliability performance. When handling the products, measures against electro static discharge, including the followings, are strongly recommended.

Eliminating the charge;

Wrist strap, ESD footwear and garments, ESD floors



· Solid-State Light. Done Right.

Grounding the equipment and tools at workstation

ESD table / shelf mat (conductive materials)

Proper grounding techniques are required for all devices, equipment and machinery used in the assembly of the products, Also note that surge protection should be considered in the design of customer products.

If tools or equipment contain insulating materials, such as glass or plastic, proper measures against electro static discharge, including the followings are strongly recommended.

Dissipating the charge with conductive materials

Preventing the charge generation with moisture

Neutralizing the charge with ionizer

When performing the characteristics inspection of the LEDs in your application, customer is advised to check on the LEDs whether or not they are damaged by ESD, Such damage can be detected during forward voltage measurement or light up test at low current. (The recommended current is 1mA or lower)

ESD-damaged LEDs may have a current flow at low voltage, or no longer light up at low current, Failure Criteria: $V_F < 0.9V$ at $I_F = 1\mu A$

(7) Others

When using the LEDs, it must care that the reverse voltage will not exceed the absolute maximum rating. The LED light is enough to injure human eyes, so it should avoid looking at LED light directly.

NOTE.

All the information published is considered to be reliable. However, AOT does not assume any liability arising out of the application or use of any product described herein.

AOT reserves the right to make changes at any time without notice to any products in order to improve reliability, function or design.

AOT products are not authorized for use as critical components in life support devices or systems without the express written approval from the managing director of AOT.